

**Road Planning and Design Manual
Edition 2: Volume 3**

**Supplement to Austroads Guide to Road Design
Part 4A: Unsignalised and Signalised Intersections**

November 2021

Copyright

© The State of Queensland (Department of Transport and Main Roads) 2021.

Licence



This work is licensed by the State of Queensland (Department of Transport and Main Roads) under a Creative Commons Attribution (CC BY) 4.0 International licence.

CC BY licence summary statement

In essence, you are free to copy, communicate and adapt this work, as long as you attribute the work to the State of Queensland (Department of Transport and Main Roads). To view a copy of this licence, visit: <https://creativecommons.org/licenses/by/4.0/>

Translating and interpreting assistance



The Queensland Government is committed to providing accessible services to Queenslanders from all cultural and linguistic backgrounds. If you have difficulty understanding this publication and need a translator, please call the Translating and Interpreting Service (TIS National) on 13 14 50 and ask them to telephone the Queensland Department of Transport and Main Roads on 13 74 68.

Disclaimer

While every care has been taken in preparing this publication, the State of Queensland accepts no responsibility for decisions or actions taken as a result of any data, information, statement or advice, expressed or implied, contained within. To the best of our knowledge, the content was correct at the time of publishing.

Feedback

Please send your feedback regarding this document to: tmr.techdocs@tmr.qld.gov.au

Relationship with Austroads Guide to Road Design – Part 4A (2021)

The Department of Transport and Main Roads has, in principle, agreed to adopt the standards published in the *Austroads Guide to Road Design (2021) Part 4A: Unsignalised and Signalised Intersections*.

When reference is made to other parts of the *Austroads Guide to Road Design*, *Austroads Guide to Traffic Management* or the *Austroads Guide to Road Safety*, the reader should also refer to Transport and Main Roads related manuals:

- *Road Planning and Design Manual (RPDM)*
- *Traffic and Road Use Management Manual (TRUM)*.

Where a section does not appear in the body of this supplement, the *Austroads Guide to Road Design – Part 4A* criteria is accepted unamended.

This supplement:

1. has precedence over the *Austroads Guide to Road Design – Part 4A* when applied in Queensland
2. details additional requirements, including *accepted with amendments* (additions or differences), *new* or *not accepted*.
3. has the same structure (section numbering, headings and contents) as *Austroads Guide to Road Design – Part 4A*.

The following table summarises the relationship between the *Austroads Guide to Road Design – Part 4A* and this supplement using the following criteria:

Accepted	Where a section does not appear in the body of this supplement, the <i>Austroads Guide to Road Design – Part 4A</i> is accepted.
Accepted with amendments	Part or all of the section has been accepted with additions and/or differences.
New	There is no equivalent section in the <i>Austroads Guide</i> .
Not accepted	The section of the <i>Austroads Guide</i> is not accepted.

Austroads Guide to Road Design – Part 4A	RPDM relationship
<u>1 Introduction</u>	
1.1 Purpose	Accepted
1.2 Scope of this Part	Accepted
1.3 Design Criteria in Part 4A	Accepted with amendments
1.4 Intersection Safety and the Safe System Approach	Accepted with amendments
1.5 Grade Separation of Traffic Movements	Accepted with amendments
<u>2 Layout Design Process</u>	
2.1 Design Process	Accepted with amendments
2.2 Alignment of Intersection Approaches	Accepted with amendments
2.3 Bicycles	New

Austrroads Guide to Road Design – Part 4A	RPDM relationship
<u>3 Sight Distance</u>	
3.1 General	Accepted
3.2 Sight Distance Requirements for Vehicles at Intersections	Accepted with amendments
3.3 Pedestrian Sight Distance Requirements	Accepted with amendments
3.4 Sight Distance at Property Entrances	Accepted with amendments
<u>4 Types of Intersection and Their Selection</u>	
4.1 General	Accepted with amendments
4.2 Intersection Types	Accepted
4.3 Warrants for BA, AU, and CH Turn Treatments	New
4.4 Median Turning Lanes or Two Way Right-Turn Lanes (TWRTL) on an Urban Road	New
<u>5 Auxiliary Lanes</u>	
5.1 General	Accepted
5.2 Deceleration Lanes	Accepted with amendments
5.3 Acceleration Lane for Cars	Accepted with amendments
5.4 Acceleration Lanes for Trucks	Accepted
5.5 Auxiliary Through-lane Design	Accepted with amendments
<u>6 Traffic Islands and Medians</u>	
6.1 Raised Traffic Islands and Medians	Accepted with amendments
6.2 Painted Traffic Islands and Medians	Accepted
6.3 Desirable Clearances to Traffic Islands and Medians	Accepted
6.4 Road Width between Kerbs and between Kerb and Safety Barrier	Accepted with amendments
6.5 Kerb and Channel	Accepted with amendments
<u>7 Right-turn Treatments</u>	
7.1 Design Procedure	Accepted
7.2 Rural Right-left Staggered T-intersection	Accepted
7.3 Rural Right-turn Treatments – Divided Roads	Accepted
7.4 Rural Wide Median Treatment	Accepted with amendments
7.5 Urban Right-turn Treatments – Undivided Roads	Accepted
7.6 Urban Right-turn Treatments – Divided Roads	Accepted with amendments
<u>8 Left-turn Treatments</u>	
8.1 General	Accepted with amendments
8.2 Rural Left-turn Treatments	Accepted with amendments
8.3 Urban Left-turn Treatments	Accepted with amendments
<u>9 Signalised Intersections</u>	
9.1 Design Process	Accepted with amendments
9.2 Sight Distance	Accepted with amendments
<u>References</u>	
References	Accepted with amendments

Austrroads Guide to Road Design – Part 4A	RPDM relationship
<u>Appendices</u>	
Appendix A Extended Design Domain (EDD) for Intersections	Accepted with amendments
Appendix B Truck Stability at Intersections	Accepted with amendments
Appendix C Swept Paths for Road Trains at High Entry Angle Left-Turn Treatments	Accepted
Appendix D Basic Left-turn (BAL) Layouts at Rural Intersections	New
<u>Commentaries</u>	
Commentary 1	Accepted
Commentary 2	Accepted
Commentary 3	Accepted
Commentary 4	Accepted
Commentary 5	Accepted
Commentary 6	New

Contents

- 1 Introduction1**
- 1.3 Design criteria in Part 4A 1
- 1.4 Intersection safety and the safe system approach 1
- 1.5 Grade separation of traffic movements 1
- 2 Layout design process.....1**
- 2.1 Design process 1
- 2.2 Alignment of intersection approaches 2
 - 2.2.1 *Horizontal alignment*.....2
 - 2.2.2 *Vertical alignment*.....2
- 2.3 Bicycles 3
- 3 Sight distance4**
- 3.2 Sight distance requirements for vehicles at intersections 4
 - 3.2.2 *Safe Intersection Sight Distance (SISD)*4
 - 3.2.3 *Minimum Gap Sight Distance (MGSD)*.....5
- 3.3 Pedestrian sight distance requirements 5
- 3.4 Sight distance at property entrances 5
- 4 Types of intersection and their selection.....6**
- 4.1 General 6
- 4.3 Warrants for BA, AU and CH turn treatments..... 6
- 4.4 Median turning lanes or Two-Way Right-Turn Lanes (TWRTL) on an urban road 6
- 5 Auxiliary lanes.....7**
- 5.2 Deceleration lanes 7
 - 5.2.2 *Determination of deceleration turning lane length*.....7
- 5.3 Acceleration lane for cars 8
 - 5.3.1 *General*.....8
 - 5.3.2 *Acceleration distance*8
 - 5.3.4 *Other considerations* 10
- 5.5 Auxiliary through-lane design 11
- 6 Traffic islands and medians 11**
- 6.1 Raised traffic islands and medians 11
 - 6.1.1 *Raised islands* 11
 - 6.1.3 *Raised high-entry angle and free-flow left-turn islands*..... 12
 - 6.1.4 *Simple high entry angle design process* 12
- 6.4 Road width between kerbs and between kerb and safety barrier 12
- 6.5 Kerb and channel..... 13
 - 6.5.1 *General*..... 14
- 7 Right-turn treatments 14**
- 7.4 Rural wide median treatment..... 15
- 7.6 Urban right-turn treatments – Divided roads 15
 - 7.6.1 *Channelised Right-turn (CHR) on divided urban roads*..... 15
 - 7.6.3 *Seagull treatments on divided urban roads*..... 15

8	Left-turn treatments	15
8.1	General	15
8.1.3	<i>Sight distance requirements</i>	16
8.2	Rural left-turn treatments	17
8.2.1	<i>Rural Basic Left-turn treatment (BAL)</i>	17
8.2.5	<i>Offset rural Channelised Left-turn lane treatment (CHL)</i>	18
8.3	Urban left-turn treatments	19
8.3.1	<i>Urban auxiliary left-turn treatment (AUL) on the major road</i>	19
8.3.2	<i>Left-turn treatments for large vehicles</i>	19
9	Signalised intersections	20
9.1	Design process	20
9.2	Sight distance	20
	References	21
	Appendix A – Extended Design Domain (EDD) and Design Exception (DE) and potential mitigation strategies for intersections	22
A.1	General	22
A.2	EDD for sight distance at intersections.....	22
A.2.2	<i>Base and check cases</i>	22
A.2.5	<i>EDD Safe Intersection Sight Distance (SISD)</i>	22
A.5.7	<i>Turning lanes</i>	22
A.5.8	<i>Private accesses</i>	23
A.6	EDD treatment of a constrained left-turn radius	24
A.10	EDD warrants for intersection turn treatments	26
A.11	Island size.....	31
A.11.1	<i>Mitigation</i>	32
	Appendix B – Truck stability at intersections	33
B.2	Lateral friction force on vehicles	33
	Appendix D – Basic Left-Turn (BAL) layouts at rural intersections	34
	Commentary 6	37

Tables

Table 4A-1 - Walking speeds for senior pedestrians	5
Table 4A-2 - Length of acceleration lanes for cars on level grade.....	8
Table 4A-3 - Correction of acceleration distances as a result of grade	9

Figures

Figure 4A-1 – Safe intersection sight distance.....	4
Figure 4A-2 – Two-way right-turn lanes on an urban road.....	7
Figure 4A-3 - Procedure for plotting a merge on a curved alignment using offsets from a straight road	11

Figure 4A-4 - Example of island treatments showing clearances at an intersection with single lane carriageways and no specific bicycle facilities	13
Figure 4A-5 - Offset rural CHL treatment	19
Figure 4A-A 1 - Example private entrance widening - Hook right-turns	24
Figure 4A-A 2 - Basic EDD Left-turn Treatment (BAL) on an urban road	25
Figure 4A-A 3 - Basic Left-turn Treatment (BAL) on a rural road, side road < 50vpd AADT	26
Figure 4A-A 4 - Warrants - Major road turn treatments - Extended Design Domain	28
Figure 4A-A 5 - Calculation of the major road traffic volume parameter 'Q _M '	30
Figure 4A-D 1 - Details of type 'BAL' layout for rural sites to suit B-double operation	34
Figure 4A-D 2 - Details of type 'BAL' layout for rural sites to suit type 1 (double) road train operation	35
Figure 4A-D 3 - Details of type 'BAL' layout for rural sites to suit type 2 (triple) road train operation ...	36

1 Introduction

1.3 Design criteria in Part 4A

Difference

There is an editorial error in the 2nd sentence in the 2nd paragraph in *Austroads Guide to Road Design – Part 4A*. The sentence should read 'Appendix A contains Extended Design Domain (EDD) values ...'

Addition

Guidance on the use of values outside of the design domain (Normal and Extended) should be undertaken in accordance with this document and the Transport and Main Roads *RPDM Volume 3, Part 1*.

1.4 Intersection safety and the safe system approach

Addition

A Safe System approach to urban intersections is to design to optimise conditions for people walking and cycling. The key conflict is where a turning motor vehicle driver fails to give way and could hit a person continuing straight. Crash severity should be mitigated by designing for safer vehicle turning speed and improving observation angles. To achieve this, high speed difference at conflict points should be avoided such as at channelised left-turns. Protected intersections with separated cycle tracks provide a safe intersection for all road users. Refer to Transport and Main Roads Guideline *Selection and Design of Cycle Tracks* for further information.

Transport and Main Roads Traffic Control (TC) Sign TC1775 is intended to warn other road users at junctions where motorcyclists have a history of being hit by turning traffic.

Speed has been identified as a major contributing factor to the occurrence and severity of many crashes at intersections. At rural intersections this factor is exacerbated due to the high-speed differential between conflicting movements. *Austroads Methods for Reducing Speeds on Rural Roads – Compendium of Good Practice, AP-R449-14* describes methods for reducing speeds on rural roads and includes a range of treatments for application at rural intersections.

1.5 Grade separation of traffic movements

Addition

A Safe System approach removes conflicts first, and then mitigates conflicts second. At urban intersections a Safe System outcome would be to provide grade separation, where appropriate, for vulnerable road users, for example, people walking and cycling, to eliminate conflicts with motorised vehicles – see Transport and Main Roads Guideline *Bicycle Rider and Pedestrian Underpasses*.

2 Layout design process

2.1 Design process

Addition

In Table 2.1 of *Austroads Guide to Road Design – Part 4A*, the term 'cycle tracks', is to be added to the second line in the Key considerations column corresponding to the third row relating to Traffic lanes such that it reads – 'Road function may require bus lanes, transit lanes, tram lines, cycle tracks or bicycle lanes'.

2.2 Alignment of intersection approaches

Addition

Treatments that reduce exposure, reduce the number of conflict points, encourage safe turning speeds, and highlight conflict points and reduce impact speeds if the conflicts do occur, improve intersection safety for all road users.

Where motorised vehicles cross the path of people walking or people cycling, high severity conflicts can result, even if the relative speed is low. For example, for people walking or people cycling, the fatality risk when hit by a vehicle travelling at 50 km/h is twice as high as the risk at 40 km/h and is more than five times the risk compared to a vehicle travelling at 30 km/h at the conflict point. To reduce the severity if a crash occurs involving a vulnerable road user, urban intersection design should reduce the possible impact speed to as low as possible (<30 km/h) – some examples of how this might be achieved are shown in Transport and Main Roads Guidelines *Selection and Design of Cycle Tracks and Raised Priority Crossings for Pedestrians and Cycle Paths*.

2.2.1 Horizontal alignment

Addition

The alignment of intersecting roads at an intersection should preferably consist of:

- a minimum straight section of road, equivalent in length to two seconds travel time at the design speed on both upstream and downstream sides of the intersection (most desirable), or
- a continuous curve of constant radius through the intersection (less desirable) with tangent points located at a distance no less than the equivalent in length to two seconds travel time at the design speed either side of the intersection.

It is not good practice to have a straight approach followed by a tight curve on the downstream exit from an intersection.

Careful attention to the design of minor road legs of unsignalised intersections with high approach speeds is required as these legs record high crash rates.

Intersections on the outside of small radius horizontal curves should also preferably be avoided, especially on curves with a large deflection angle.

On curved horizontal alignments at intersections, careful attention must be paid to the location and height of kerb profiles. The use of over-run kerb profiles may be required to accommodate design or check vehicle paths.

2.2.2 Vertical alignment

Addition

The vertical profile of the major road at the intersection should consider the following:

- Should preferably be located within a sag curve with relatively gentle slopes to the intersection or on a section of relatively flat vertical grade.
- Where intersections are located on grades on the major road, the grade should preferably be less than 3% but can be accepted on grades of up to 6% with consideration given to the additional stopping / decelerating distance required in the downhill direction.
- Steeper grades can lead to problems with perception of the intersection in the uphill direction and stopping / deceleration issues in the downhill direction.

- If an intersection must be located within a large radius crest vertical curve, it can be located anywhere on the crest provided all sight distance parameters are met.
- Intersections located on short radii crest curves should be located at the apex of the crest (not either side) and, preferably, on straight horizontal alignment. These locations apply only to brownfields locations.

2.3 Bicycles

There is no equivalent Section 2.3 in *Austroads Guide to Road Design – Part 4A*.

New

Intersections are areas of high conflict and can be difficult for cyclists to traverse. The following additional documents should be reviewed for additional specific design guidance for bicycles:

- Transport and Main Roads Technical Guidelines for Cyclists and Pedestrians (via the departmental website <https://www.tmr.qld.gov.au/business-industry/Technical-standards-publications/Cycling-guidelines>), and
- Transport and Main Roads *Traffic and Road Use Management Manual* (TRUM).

Transport and Main Roads requires the design for bicycles to be an integral part of the design of the various components of the road, not an ‘add-on’ after the basis for the design has been established.

In accordance with the Transport and Main Roads *Cycling Infrastructure Policy*, road upgrades are to incorporate ‘cycle-friendly’ designs. Along priority cycling routes, these cycle friendly designs are marked cycle lanes, cycle paths, shared paths or other facilities for cyclists.

A ‘cycle-friendly’ design feature of urban intersections is the provision of 1 m minimum offsets from the edge of lane to kerb faces where there is no other provision for cyclists (e.g. there is no separate bicycle lane). This is to avoid cyclists having to negotiate ‘squeeze points’ at the intersection. On the major road in rural areas, the minimum offset is the greater of the shoulder width and 1 m.

If bicycle lanes are present either side of an intersection, specific cycle facilities are to be provided to guide cyclists through the intersection. Even a short-marked cycle lane through an intersection that does not provide route continuity may provide safety advantages to cyclists provided that its termination point does not lead cyclists into an unsafe situation.

Where there are a high number of cyclists or an intersection has a poor cycle safety record, a green coloured pavement surface for the cycle lane may deliver added cycle safety. Refer to the Transport and Main Roads TRUM Manual for guidance on the use of green coloured pavement surfaces.

Wide kerbside lanes enable greater separation of cyclists and motor vehicles, creating a higher level of safety and increased operational efficiency. Wide kerbside lanes should be carried through intersections to avoid ‘squeeze points’.

Where a road is identified as a principal cycling route, a bike lane treatment on the uphill leg(s) may be appropriate to account for side-to-side movement of the bicycle and the large speed differential between bicycles and motorised vehicles uphill. A bicycle lane is also desirable on the downhill leg(s).

3 Sight distance

3.2 Sight distance requirements for vehicles at intersections

Addition

Safe Intersection Sight Distance (SISD) and Minimum Gap Sight Distance (MGSD) represent separate and independent sight distance models. It cannot be assumed that meeting the requirements of one will be sufficient to meet the requirements of the other. It is mandatory that each of these sight distance models are checked and adequately provided for as part of the design process for all intersections and property accesses.

3.2.2 Safe Intersection Sight Distance (SISD)

Difference

Figure 3.2 of *Austroads Guide to Road Design – Part 4A* incorrectly depicts the location of the driver position based on distance from the lip of channel or edge line. In the current version of *Austroads Guide to Road Design – Part 4A* (2021), this location is measured from the conflict point. The top portion of Figure 3.2 is therefore replaced with the Figure 4A-1.

Figure 4A-1 – Safe intersection sight distance

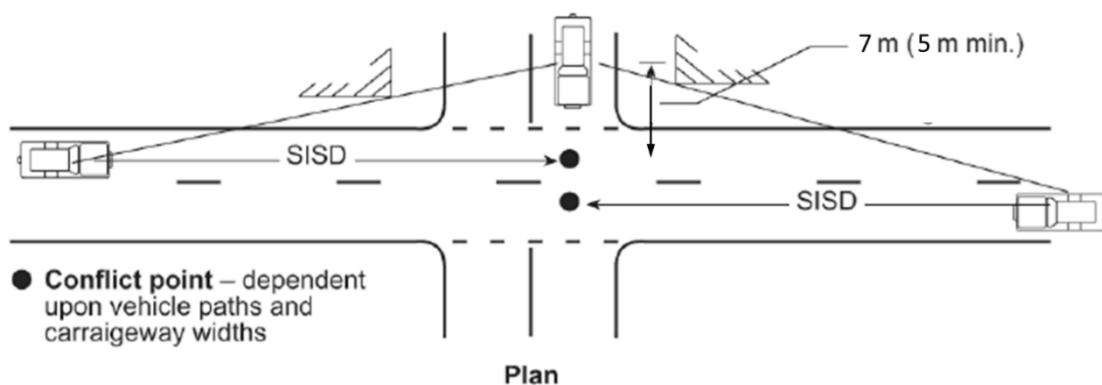

Addition

The time gaps provided by applying the SISD model are generally sufficient for heavy vehicles to undertake the following movements:

- left or right-turn from the minor road onto the major road
- through movement from the minor road at a cross intersection, and
- right-turn from the major road into the minor road.

However, the time gaps may not be sufficient for heavy vehicles to undertake these movements in particular circumstances, for example:

- where the design heavy vehicle is greater than a 19 m semi-trailer
- the major road is on a steep grade, and
- the major road comprises more than one lane in each direction.

Under such circumstances, advice from Transport and Main Roads' specialists should be sought as to whether the minimum values of SISD are sufficient to cover the particular heavy vehicle movements.

3.2.3 Minimum Gap Sight Distance (MGSD)

Addition

An additional note is added to Table 3.5 of *Austroads Guide to Road Design – Part 4A* as follows:

Note: the critical acceptance gaps (t_a) listed are based on simple road layouts with an assumed 3.5 m wide lane and no median width to cross. Any geometric features that increase the crossing distance therefore require an increase in the values of t_a to be applied. These factors include, a skewed crossing path, auxiliary turn lanes and bicycle lanes, wide centreline treatments and narrow medians.

3.3 Pedestrian sight distance requirements

Addition

Pedestrian walking speeds can vary significantly and are affected by age, sex, motivation, presence of other pedestrians and other traffic impediments. The distribution of free flow walking speeds varies as follows:

- minimum walking speed 0.74 m/s
- maximum walking speed 2.39 m/s
- maximum speed of wheelchairs 10 km/h = 2.78 m/s (wheelchairs are classified as pedestrians in legislation), and
- average unimpeded free-flow 1.35 m/s walking speed.

Calculation of green time at traffic signals is based on an average design walking speed of 1.2 m/s, but this is still faster than some pedestrians can manage. In particular, elderly pedestrians often adopt significantly lower speeds than the younger part of the population. Table 4A-1 provides guidance on the walking speed to adopt for various circumstances.

Table 4A-1 - Walking speeds for senior pedestrians

Walking Pace	Mean Speed (m/s)	10th Percentile Speed (m/s)
Normal	1.13	0.8
Hurried	1.41	1.0
Rushing	1.71	1.0

3.4 Sight distance at property entrances

Addition

In existing, constrained situations, where it is deemed impractical to achieve the sight distance criteria as described in *Austroads Guide to Road Design – Part 4A*, it should be sought, as a minimum, to comply with the sight distance criteria as per Section 3.2.4 – Sight distance at access driveway exits, in Australian Standard AS 2890.1:2004 *Parking facilities – Off-street car parking*.

At many properties (for example major shopping centres), the entrance may appear to a driver to be an intersection as opposed to the more common form of a property entrance. Due to the variety of different designs and pavement/kerb treatments that can be used at property entrances, no clear distinction can be made as to what is an intersection and what is a property entrance.

In considering the sight distance requirements to be applied at a property entrance, a judgement is to be made on the basis that if drivers are likely to consider that a property entrance looks like an intersection, then it should be designed in accordance with the requirements for an intersection.

4 Types of intersection and their selection

4.1 General

Addition

Where urban roundabouts or signalised intersections are located on a bicycle route, protected intersections and cycle tracks should be considered. Refer Transport and Main Roads Guideline *Selection and Design of Cycle Tracks*, Section 4.

4.3 Warrants for BA, AU and CH turn treatments

There is no equivalent Section 4.3 in *Austroads Guide to Road Design – Part 4A*.

Refer to RPDM, *Supplement to Austroads Guide to Road Design - Part 4A*, Appendix A, Section A.10.

New

An EDD version of these warrants for potential application at constrained and brownfields sites is provided at Appendix A.10 of this RPDM, *Supplement to Austroads Guide to Road Design, Part 4A*. Further commentary on the methodology behind these warrants is provided at Commentary 6 of this document.

4.4 Median turning lanes or Two-Way Right-Turn Lanes (TWRTL) on an urban road

There is no equivalent Section 4.4 in *Austroads Guide to Road Design – Part 4A*.

New

Median Turning Lanes or Two-Way Right-turn Lanes (TWRTL) can be used to maintain capacity and level of service for the through lanes by removing the obstruction caused by a right-turning vehicle. It has the added advantage of providing shelter for vehicles both entering and exiting from an access. A diagram of such a treatment is shown in Figure 4A-2.

This treatment is particularly applicable in commercial and residential areas with closely spaced access points. It has been used successfully where arterial roads bisect country town business and industrial areas and access is required for motels, service centres commercial establishments and adjoining low traffic volume side streets.

TWRTLs should not be introduced without consideration of existing and future land use. They should not be allowed to provide unlimited and uncontrolled right-turn movements. However, when used on roads with traffic signal control, TWRTLs may provide sufficient gaps to adequately service low volume side properties with efficiency and safety. In non-access controlled areas, they can encourage ad-hoc land development with inappropriate accesses provided at developments.

On new heavily travelled arterial roads and commercial and industrial areas with widely spaced access points, median control of right-turn movements is preferred.

TWRTLs should be restricted to the urban environment with travel speeds of 70 km/h or less. They should not be used in high density residential areas due to the potential conflict with uncontrolled pedestrian movements.

A TWRTL must not be used in conjunction with an intersection. The ends of the TWRTL treatment must not be closer than 10 m from the start of any right-turn lane at an intersection.

The through road should have no more than two lanes in each direction resulting in a total of five lanes with the introduction of a TWRTL.

Geometric considerations

The TWRTL is to be paved flush with the adjacent lanes. To improve the definition of the lane a different coloured pavement material other than red (Bus Only lanes) or green (Cycle lanes) can be used. The desirable width is 3 m to 4.8 m. TWRTLs and right-turn auxiliary lanes within the same length of median must be separated by a raised island and adequately sign posted.

Figure 4A-2 – Two-way right-turn lanes on an urban road

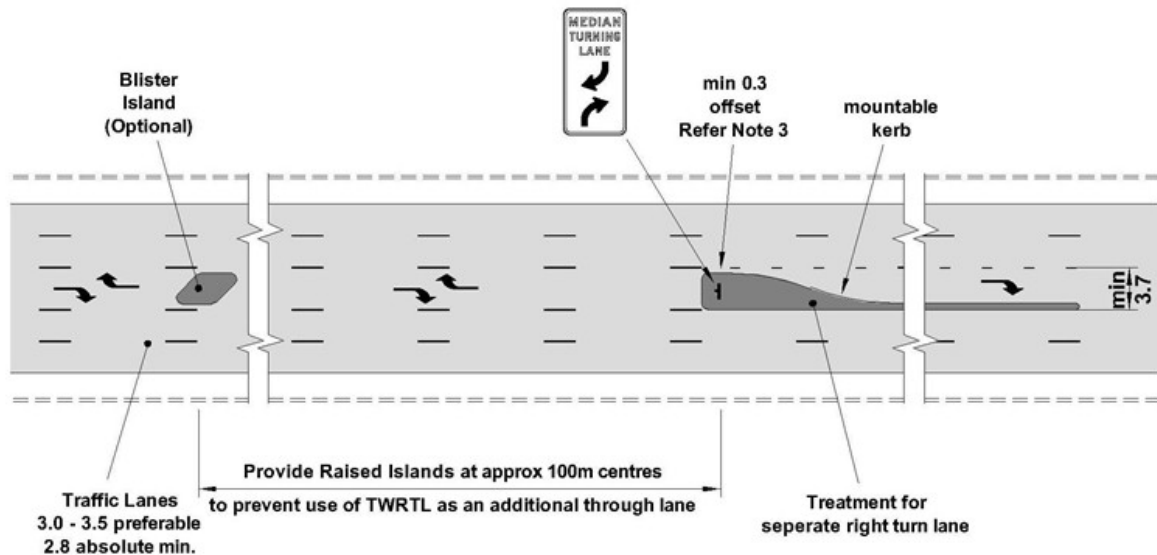

Notes:

1. This diagram does not show any specific bicycle facilities. Where specific bicycle facilities are required (e.g. exclusive bicycle lanes), refer *Austroads Cycling Aspects of Austroads Guides AP-G88-17*.
2. See *Transport and Main Roads Manual of Uniform Traffic Control Devices (MUTCD)* for linemarking, spacing of pavement arrows, advance warning and regulatory signs.
3. Minimum offset is as per Figure 6.3 of *Austroads Guide to Road Design – Part 4A*.
4. Diagram shows two lanes in each direction, but this treatment can be used for roads with a single lane in each direction.

5 Auxiliary lanes

5.2 Deceleration lanes

5.2.2 Determination of deceleration turning lane length

Addition

Low to moderate speed urban arterial road intersections

Where the entry to the auxiliary left lane crosses a bicycle lane on the approach to an urban intersection, a high-speed conflict area can result in high severity rear-end and side-swipe crashes. In urban areas, this conflict can be avoided by designing a transition from bicycle lane to cycle track and a protected intersection. Refer *Transport and Main Roads Guideline Selection and Design of Cycle Tracks*, Section 4.

5.3 Acceleration lane for cars

5.3.1 General

Addition

Note to Figure 5.4 of *Austroads Guide to Road Design – Part 4A*. The emergency run-off area is to be designed as per the requirements detailed in RPDM, Volume 3, Part 3, Geometric Design, Section 9.9.2.

At intersections on urban roads where people are likely to be walking or cycling, free flow acceleration lanes can result in conflicts, therefore it is recommended in such situations to consider alternative turn treatments. Transport and Main Roads Guideline *Selection and Design of Cycle Tracks* presents intersection forms which mitigate the risk associated with conflicts for cyclists.

5.3.2 Acceleration distance

Difference

All references to Tables 5.5 and 5.6 in this section of *Austroads Guide to Road Design – Part 4A* are to be replaced respectively with references to Tables 4A-2 and 4A-3.

Replace 'Table 5.5: Length of acceleration lanes for cars on a level grade (and associated notes)' with Table 4A-2 (and associated notes).

Table 4A-2 - Length of acceleration lanes for cars on level grade

Design speed of road entered ⁽¹⁾ (km/h)	Length of acceleration lane A (m) (including length of merge taper) – for flat grade								4 sec travel (m)	Merge T _M (M)	Min desirable length 4 sec + T _M ⁽³⁾
	Design speed of entry curve (km/h)										
	0 ⁽²⁾	20	30	40	50	60	70	80			
50	70	60	50	30	-	-	-	-	55	50	105
60	100	95	85	65	35	-	-	-	65	60	125
70	140	135	125	105	75	45	-	-	80	70	150
80	215	205	195	175	150	115	75	-	90	80	170
90	300	295	280	265	235	200	160	90	100	90	190
100	405	395	385	365	340	305	265	195	110	100	210
110	600	590	580	560	535	500	460	385	120	105	225

Notes:

- For the purpose of calculating the acceleration lane lengths at intersections, the speed reached is usually made equal to the mean free speed of the through road as defined in the *RPDM Volume 3, Part 3 Geometric Design*. In the absence of local data, it can be assumed that the mean free speed is approximately equal to the speed limit.
- Length required where a vehicle accelerates from a zero speed.
- Minimum desirable values have been rounded.

General Notes:

- Values in the non-shaded areas are based on the distance required to accelerate from the turning speed to the mean free speed of the road being entered.
- For values in the green-shaded areas adopt the minimum desirable length as in this area of the table these values are greater than the distance to accelerate from the turning speed to the design speed of the road being entered.

- Values shown in table are for level grade. Adjust for grade using Table 4A-3. Flat grade is any road with a grade given by 1% downgrade ≤ grade ≤ 1% upgrade.

The values in Tables 4A-2 and 4A-3 have been generated from VEHSIM acceleration curves for a typical car. The VEHSIM curves are reproduced in RPDM, Volume 3, Part 4C Interchanges, Commentary 9.

In practice the vertical profile of an acceleration lane may consist of sections of varying grade due to design issues such as the natural topography or other constraints. In these situations, the overall length of the acceleration lane required can be established by determining the vehicle speed at the start of the final section of grade, and determining the remaining length required for vehicles to meet the required design speed. A worked example of determining lane lengths on compound grades is included at RPDM, Volume 3, Part 4C Interchanges, Commentary 9.

Replace Table 5.6: Correction of acceleration distances as a result of grade and associated notes with Table 4A-3 (and associated notes).

Table 4A-3 - Correction of acceleration distances as a result of grade

Design speed ⁽¹⁾ of road entered (km/h)	Ratio of acceleration length on grade to acceleration length on level (Table 4A-2)															
	Design speed of turning roadway curve (km/h)															
	1% < upgrade ≤ 3%								1% < downgrade ≤ 3%							
	0	20	30	40	50	60	70	80	0	20	30	40	50	60	70	80
50	1.05	1.10	1.10	1.15					0.95	0.90	0.90	1.00				
60	1.10	1.10	1.05	1.10	1.15				0.95	0.95	0.90	0.90	1.00			
70	1.15	1.10	1.10	1.15	1.20	1.10			0.95	0.95	0.90	0.90	0.95	0.90		
80	1.15	1.15	1.15	1.15	1.15	1.15	1.15		0.90	0.90	0.85	0.90	0.85	0.85	0.80	
90	1.20	1.15	1.20	1.20	1.20	1.25	1.20	1.30	0.90	0.85	0.90	0.85	0.85	0.85	0.80	0.85
100	1.20	1.20	1.20	1.20	1.20	1.25	1.25	1.25	0.85	0.85	0.85	0.85	0.85	0.85	0.85	0.80
110	1.40	1.40	1.40	1.45	1.45	1.45	1.50	1.55	0.80	0.80	0.80	0.80	0.80	0.75	0.75	0.75

Design speed ⁽¹⁾ of road entered (km/h)	3% < upgrade ≤ 5%								3% < downgrade ≤ 5%							
	0	20	30	40	50	60	70	80	0	20	30	40	50	60	70	80
50	1.15	1.15	1.20	1.35					0.85	0.90	0.80	0.85				
60	1.25	1.20	1.25	1.25	1.30				0.90	0.85	0.80	0.75	0.85			
70	1.25	1.25	1.30	1.30	1.30	1.30			0.90	0.85	0.85	0.80	0.80	0.80		
80	1.35	1.40	1.40	1.45	1.45	1.50	1.60		0.80	0.80	0.75	0.75	0.75	0.75	0.65	
90	1.45	1.45	1.50	1.50	1.55	1.60	1.70	1.70	0.80	0.75	0.75	0.75	0.75	0.75	0.70	0.70
100	1.55	1.55	1.55	1.60	1.60	1.65	1.70	1.70	0.75	0.75	0.75	0.75	0.75	0.70	0.70	0.70
110⁽²⁾									0.70	0.70	0.65	0.65	0.65	0.65	0.65	0.60

Design speed ⁽¹⁾ of road entered (km/h)	5% < upgrade ≤ 6%								5% < downgrade ≤ 6%							
	0	20	30	40	50	60	70	80	0	20	30	40	50	60	70	80
50	1.30	1.35	1.40	1.50					0.85	0.85	0.80	0.85				
60	1.40	1.35	1.40	1.45	1.55				0.85	0.85	0.80	0.75	0.85			
70	1.45	1.45	1.45	1.50	1.55	1.55			0.80	0.80	0.80	0.80	0.80	0.80		
80	1.75	1.80	1.80	1.90	1.95	2.10	2.40		0.75	0.75	0.70	0.70	0.70	0.65	0.60	
90	2.00	2.00	2.10	2.10	2.20	2.35	2.55	2.55	0.70	0.70	0.70	0.70	0.65	0.65	0.60	0.60
100	2.15	2.20	2.20	2.25	2.30	2.40	2.55	2.55	0.70	0.70	0.70	0.65	0.65	0.65	0.60	0.60
110⁽²⁾									0.60	0.60	0.60	0.60	0.55	0.55	0.55	0.55

Notes:

1. For the purpose of calculating the acceleration lane lengths at intersections, the speed reached is usually made equal to the mean free speed of the through road as defined in the *RPDM Volume 3, Part 3 Geometric Design*. In the absence of local data, it can be assumed that the mean free speed is approximately equal to the speed limit.
2. Empty cells at these speeds indicate that the modelled acceleration does not result in vehicles reaching 110 km/h. In these cases, the acceleration lanes should be converted to an added lane.

General Notes:

- Values in the non-shaded areas are based on the distance required to accelerate from the turning speed to the design speed of the road being entered.
- For values in the green-shaded areas adopt the minimum desirable length from Table 4A-2, as in this area of the table these values are greater than the grade corrected distance to accelerate from the turning speed to the design speed of the road being entered.

5.3.4 Other considerations

There is no equivalent Section 5.3.4 in *Austroads Guide to Road Design – Part 4A*. This section was previously included within *Austroads Guide to Road Design – Part 4A* and has been removed from the 2017 version. The department considers that this information remains worthwhile and hence the original information is now presented in this part of the RPDM.

New

For safety reasons merges should never be installed:

- Over a crest that has a sight distance less than Approach Sight Distance (ASD) or on the inside of a horizontal curve where the radius of the right-side lane line is less than:
 - 185 m for a 60 km/h design speed
 - 330 m for a 80 km/h design speed
 - 515 m for a 100 km/h design speed, and
 - 620 m for a 110 km/h design speed.

This is based on a 3.5 m lane width and a 2 s gap. For 3 m wide lanes a 20% larger radius applies.

It is also important that:

- ASD is available at all points along the merge length to allow drivers to observe the linemarking with sufficient time to react.
- Merge transitions around horizontal curves should be developed as for a straight alignment and transferred to the curved alignment by the distance and offset method. This is shown in Figure 4A-3.
- A circular curve should not be used for the merge taper, as the rate of lateral movement and reduction in width will not be uniform. In plane geometry, concentric circular arcs cannot be joined tangentially by a third circular arc, unless they are joined over exactly 180°. The curve within the merge length in the bottom half of Figure 4A-3 is obtained by linear interpolation only; it is not a circular arc.

Where an intersection is located downstream of the end of the acceleration lane it is important to verify that sufficient weaving distance is available for drivers using the acceleration lane who wish to turn right at that intersection. The same applies to drivers in the through lane who may wish to turn left at

that intersection (Figure 5.4 (b) of *Austroads Guide to Road Design – Part 4A*). This will require traffic analysis in accordance with the *Guide to Traffic Management*.

Figure 4A-3 - Procedure for plotting a merge on a curved alignment using offsets from a straight road

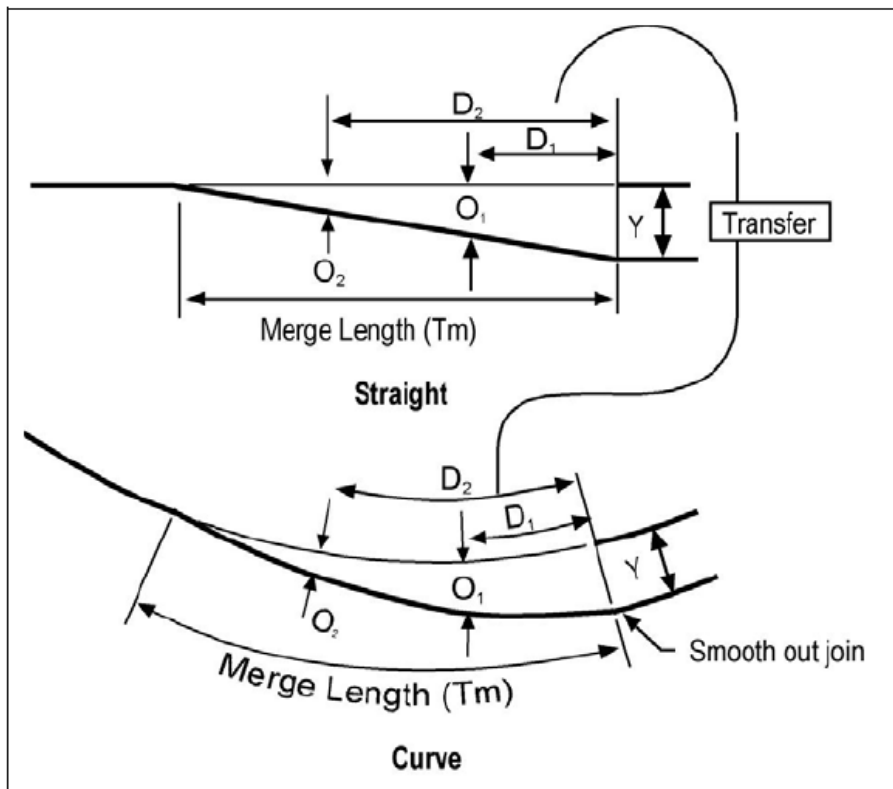

Source: Austroads (2005).

5.5 Auxiliary through-lane design

Addition

The start and termination points of an auxiliary lane should be clearly visible to approaching drivers in accordance with the sight distance requirements outline in Table 9.7 in *Austroads Guide to Road Design – Part 3* and the additional considerations for merge points discussed at Section 5.3.4.

The department requires that a run-out area be provided for the merge area of all auxiliary lanes.

6 Traffic islands and medians

Addition

General design guidance on traffic islands and medians at intersections is provided in Appendix A.6 of *Austroads Guide to Road Design – Part 4*.

6.1 Raised traffic islands and medians

6.1.1 Raised islands

Addition

Semi-mountable kerbs are preferred for raised islands and medians. However, in some locations, a barrier kerb type may be appropriate. Guidance on the selection and application of the various kerb types is discussed in Table A 3 of *Austroads Guide to Road Design – Part 4A*. Further information on

kerb types and their application in Queensland is detailed in RPDM Volume 3, Part 3 Geometric Design.

Islands at intersections should be designed to suit turning paths of design vehicles and may need to consider the use of mountable islands in some circumstances. The design of the islands should ensure that the continuity of the major road through the intersection is maintained and is legible for approaching drivers.

6.1.3 Raised high-entry angle and free-flow left-turn islands

Addition

At intersections on urban roads where people are likely to be walking or cycling, high-entry angle treatments and free-flow acceleration lanes can result in conflict, therefore in such situations consideration should be given to alternative turn treatments. Transport and Main Roads Guideline *Selection and Design of Cycle Tracks* presents intersection forms which mitigate the risk associated with conflicts for cyclists. If a left-turn slip lane is deemed necessary, it should either be signalised or have a wombat crossing (raised zebra) provided.

Channelised left-turns are not appropriate where cycle tracks continue through at an urban protected intersection – refer to Transport and Main Roads Guideline *Selection and Design of Cycle Tracks*.

6.1.4 Simple high entry angle design process

Addition

Alternative A2 – CHL turn treatment with acceleration lane

Suitable for use at rural sites but alternatives should be considered at urban sites, to minimise conflicts with people walking and people cycling – refer to Section 6.1.3 above.

Alternative B2 – CHL turn treatment with acceleration lane – Urban

The department's preference is that alternative treatments are considered to free flow acceleration lanes at urban sites, to minimise conflicts with people walking and people cycling – refer to Section 6.1.3 above.

6.4 Road width between kerbs and between kerb and safety barrier

Addition

Figure 4A-4 was previously included within *Austroads Guide to Road Design – Part 4A* and has been removed from the 2021 version. The department considers that this information remains worthwhile and hence the original information is now presented in this part of the RPDM.

Figure 4A-4 - Example of island treatments showing clearances at an intersection with single lane carriageways and no specific bicycle facilities

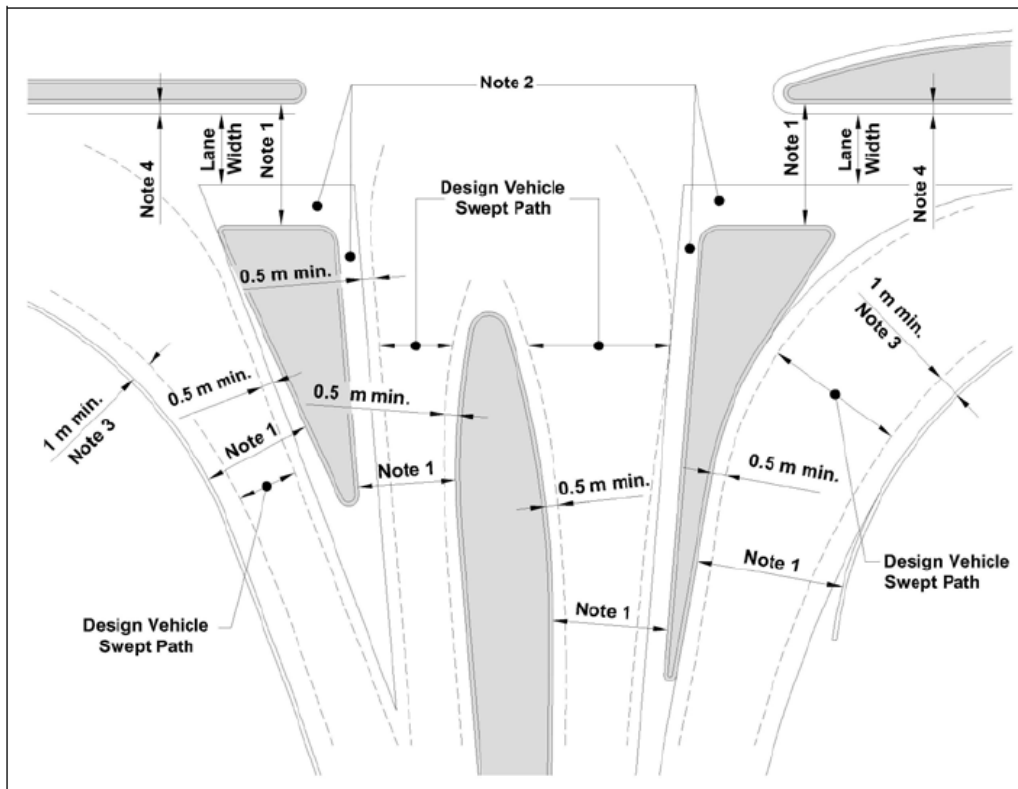

Notes:

1. Minimum desirable width between kerbs to allow for a broken-down vehicle is 5 m. This width is not mandatory if other provisions for passing broken-down vehicles are provided. Such provisions may include mountable or semi-mountable kerbing on islands / medians with sufficient offset to hardware (e.g. signs, light poles and traffic signal posts) to allow a very slow passing manoeuvre.
2. Offsets between raised islands and adjacent edge lines are given in Table 6.3 of *Austroads Guide to Road Design – Part 4A*. As no specific bicycle facilities exist in this example, a minimum 1 m offset should cater for bicycles in urban areas. The 1 m offset provides the capabilities listed in Note 3. On the major road in rural areas, the minimum offset must be the greater of the shoulder width and 1 m.
3. The 1 m offset provides:
 - a. clearance from the kerb to the design vehicle swept path
 - b. additional width for the check vehicle, and
 - c. provision for cyclists.
4. This diagram shows an intersection with no specific bicycle facilities. For intersections with specific bicycle facilities (e.g. exclusive bicycle lanes), refer to Section 8.

6.5 Kerb and channel

Addition

General design guidance on use and restrictions on use of kerb and channels at intersections is provided in Appendix A.6 of *Austroads Guide to Road Design – Part 4*.

6.5.1 General

Addition

Add the following bullet point to the third paragraph of *Austroads Guide to Road Design – Part 4A*:

- to separate cycle tracks from motor vehicle lanes

7 Right-turn treatments

Addition

A large amount of design information for right-turn treatments for unsignalised and signalised intersections has been relocated to Appendix A.7 of *Austroads Guide to Road Design – Part 4*. Austroads will be further reviewing this. The following cross-references are provided to assist designers in the interim.

Introduction

Refer to *Austroads Guide to Road Design – Part 4*, Appendix A, Section A.7.1: Introduction and the corresponding section in the RPDM, *Supplement to Austroads Guide to Road Design – Part 4*.

Opposed right-turns – General information

Refer to *Austroads Guide to Road Design – Part 4*, Appendix A, Section A.7.2.

Right-turn bans at signalised intersections

Refer to *Austroads Guide to Road Design – Part 4*, Appendix A, Section A.7.3.

Right-turn lanes for cyclists

Refer to *Austroads Guide to Road Design – Part 4*, Appendix A, Section A.7.4 and the corresponding section in the RPDM, *Supplement to Austroads Guide to Road Design – Part 4*.

Rural right-turn treatments – Undivided roads

Design guidance for all of the following right-turn facilities on undivided roads is described in *Austroads Guide to Road Design – Part 4*, Appendix A, Section A.7.5:

- Rural Basic Right-turn treatment (BAR)
- Rural Channelised T-junction – short lane type CHR(S)
- Rural Channelised T-junction – full length (CHR), and
- Rural Left-right staggered T-intersection.

Design guidance for the following is described in *Austroads Guide to Road Design – Part 4A* Section 7.2:

- Rural right-left staggered T-Junction.

Rural right-turn treatments – Undivided roads

Design guidance for the following right-turn facility is described in *Austroads Guide to Road Design – Part 4*, Appendix A, Section A.7.5:

- Rural seagull treatments.

Design guidance for the following right-turn facilities are described in *Austroads Guide to Road Design – Part 4A*, Section 7.3:

- Two stage crossing on a rural road
- Left-right staggered T-divided road, and
- Back to back right-turns on a divided road.

7.4 Rural wide median treatment

Addition

Wide Median Treatments are discussed in Section 3.2.9 of the *Austroads Guide to Traffic Management – Part 6*. These treatments, even in isolated locations, can be confusing with drivers mistaking the intersection for a roundabout. This can potentially lead to hazardous situations where traffic travelling across the median (right-turning traffic from the major road and through / right traffic from the minor road) may fail to give way to through traffic on the opposing major road. In these cases, designers should consider additional measures to further alert drivers that the wide median treatment is not a roundabout. These measures may include additional and larger signage, particularly at the give way lines within the median treatment.

7.6 Urban right-turn treatments – Divided roads

7.6.1 Channelised Right-turn (CHR) on divided urban roads

Addition

Consideration should be given to the suitability of unsignalised channelised right-turn treatments on divided urban roads if nearby signalised alternatives exist. The unsignalised treatment can require complex gap selection in multiple streams of fast and slow moving road users and may be best avoided in these circumstances.

7.6.3 Seagull treatments on divided urban roads

Addition

In addition, refer to *Austroads Guide to Road Design – Part 4*, Appendix A.7.5.

8 Left-turn treatments

8.1 General

Addition

A large amount of design information for left-turn treatments for unsignalised and signalised intersections has been relocated to the Appendix A.8 of *Austroads Guide to Road Design – Part 4*. Austroads will be further reviewing this. The following cross-references are provided to assist designers in the interim.

Types of treatments and selection

Refer to *Austroads Guide to Road Design – Part 4*, Appendix A, Section A.8.1 and the corresponding section in the RPDM, *Supplement to Austroads Guide to Road Design - Part 4*.

The form of the left-turn treatment may also need to consider the sight distance requirements for vehicles turning out of the side road. In these cases, an offset CHL or CHL(s) treatment may be required as described in Section 8.2.5 of this RPDM.

Rural left-turn treatments

Design guidance for the following left-turn facilities are described in *Austroads Guide to Road Design – Part 4A* Section 8.2:

- Rural Basic Left-turn Treatment (BAL). Refer also to Section 8.2.1 below.
- Rural Auxiliary Left-turn Treatment – Short turn lane [AUL(S)] on the major road. Section 8.2.2.
- Rural Auxiliary Left-turn Lane Treatment (AUL). Section 8.2.3, and
- Rural Channelised Left-turn Treatment (CHL) with high entry angle. Section 8.2.4.

Design guidance for the following left-turn facilities are described in *Austroads Guide to Road Design – Part 4*, Appendix A, Section A.8 and the corresponding section in the RPDM, *Supplement to Austroads Guide to Road Design - Part 4*:

- Rural Channelised Left-turn treatment (CHL) with an acceleration lane, and
- Provision for cyclists at rural free flow left-turn lanes on bicycle routes. Refer also to Section 8.2.5 below.

Design guidance for the following left-turn facilities are described in this RPDM:

- Offset rural Channelised Left-turn lane treatment (CHL). Refer to Section 8.2.5 below.

Urban left-turn treatments

Design guidance for the following left-turn facilities are described in *Austroads Guide to Road Design – Part 4*, Appendix A, Section A.8.2 and the corresponding section in the RPDM *Manual, Supplement to Austroads Guide to Road Design - Part 4*:

- Urban Auxiliary Left-turn Treatment – short turn lane [AUL(S)] major road.
- Urban Channelised Left-turn Treatment (CHL) with high entry angle.
- Urban Channelised Left-turn Treatment (CHL) with acceleration lane, and
- Provision for cyclists at urban channelised treatments. Refer also to Section 8.3.1 below.

Design guidance for the following left-turn facilities are described in *Austroads Guide to Road Design – Part 4A*, Section 8.3:

- Urban Auxiliary Left-turn Treatment (AUL) on the major road. Section 8.3.1, and
- Left-turn Treatments for larger vehicles. Section 8.3.2.

8.1.3 Sight distance requirements

There is no equivalent Section 8.1.3 in *Austroads Guide to Road Design – Part 4A*.

New

General sight distance requirements are set out in Section 3.2.

When the minor road angle of approach to an intersection exceeds 120° (that is 60° or less between the left-turning vehicle and vehicles approaching from the right) it can result in a driver losing stereo vision. Drivers only able to sight approaching traffic with the right eye lose depth of field vision and can have difficulty in accurately detecting the position and speed of approaching traffic.

In existing situations, where sighting requirements to approaching vehicles are below the criteria explained in Section 3.2 and Section 8.1.3, the following remedial treatments should be considered:

a) Reconstruction

Reconstruction of the left-turn to overcome sighting problems may be an option. By providing a protected acceleration lane on the departure side of the turn, observation angle criteria are no longer applicable and are replaced by merging requirements.

Generally, acceleration lanes are associated with multi radii (three centred curve) returns. If a left-turn slip lane exists without a protected acceleration lane, and the observation angle exceeds 120°, reconstruction to a high entry angle turn may be appropriate (refer to *Austroads Guide to Road Design – Part 4*, Section A.8.2 for details).

Elimination of the slip lane, and provision of a single radius return, may be appropriate depending upon capacity requirements.

Relocation of an intersection to overcome sighting problems is generally more practical in rural areas than in urban situations.

b) Reduce approach speed

The traffic speed on the priority road is reduced to ensure that the available sight distance meets sight requirements. This is generally only possible on local streets where effective speed control measures, such as speed humps, thresholds, or similar forms of speed control, can be introduced.

On collector, sub arterial and arterial roads, speed reduction can be achieved with a roundabout (mostly urban application) but different sight requirements will then apply. However, roundabouts can create problems where there are high volumes of other road users (e.g. motorcyclists, pedestrians and cyclists). Roundabouts should not be used solely as a speed control device to remedy sight distance deficiencies.

Speed zoning over short, isolated lengths is undesirable.

c) Provide traffic signals

Traffic signals can be used to resolve safety problems when sight distances are deficient. This solution can be costly and network consequences must be carefully examined (particularly in terms of delay). However, note that sight distance requirements are still applicable at intersections controlled by traffic signals (refer to Section 9.2).

d) Banning the turn

This is the final available option and should only be applied when convenient alternative access is available and the effect on the road network acceptable. Banning a left-turn out of a minor road can only be effectively achieved by banning all movements turning out of the minor road.

8.2 Rural left-turn treatments

8.2.1 Rural Basic Left-turn treatment (BAL)

Addition

Figure 8.2 in *Austroads Guide to Road Design – Part 4A* shows a widened shoulder for movements from the major to minor road which is based on a left-turning vehicle having a speed reduction of

30 percent in the through lane, prior to moving onto the shoulder and decelerating. This is based on the assumption that drivers decelerate at a maximum value of 3.5 m/s^2 ($d = 0.36$) from the start of the taper to the start of the kerb return. The total width of through lane plus widened shoulder is a minimum of 6 m.

Figure 8.2 in *Austroads Guide to Road Design – Part 4A* also shows an optional kerb return, which can provide the following advantages:

- better perception of the intersection, especially for intersections with limited visibility
- reduce the amount of 'corner cutting' by drivers, and
- reduce the amount of scouring in areas of high rainfall, if provided with batter protection for the drainage paths.

An EDD version of *Austroads Guide to Road Design – Part 4A* Figure 8.2, that can be used at low volume intersections where there are not significant numbers of heavy vehicles is given in Appendix A.6 (EDD treatment of a constrained left-turn radius).

8.2.5 Offset rural Channelised Left-turn lane treatment (CHL)

There is no equivalent Section 8.2.5 in *Austroads Guide to Road Design - Part 4A*.

New

Significant numbers of vehicles, particularly heavy vehicles making a left-turn from the major road at an intersection with an AUL/AUL(s)/CHL/CHL(s), may restrict the sight distance for vehicles turning out of the minor road, particularly right-turning vehicles.

In this situation, offsetting the left-turn lane from the adjacent through lane on the minor road improves the sight distance for vehicles turning out of the minor road. In particular sight distance to vehicles following a left-turning vehicle can be substantially improved. An offset left-turn lane should therefore be considered at an intersection where sight distance past left-turning vehicles may improve the intersection safety.

The factors that may warrant the use of an offset rural channelised left-turn lane include:

- high through traffic volumes on the major road
- high proportion / number of vehicles (particularly heavy vehicles) turning left from the major road
- the capacity of the turning movements from the minor road and resultant delays to vehicles, and
- intersection geometry and sight lines.

A diagrammatic layout for the intersection is shown at Figure 4A-5.

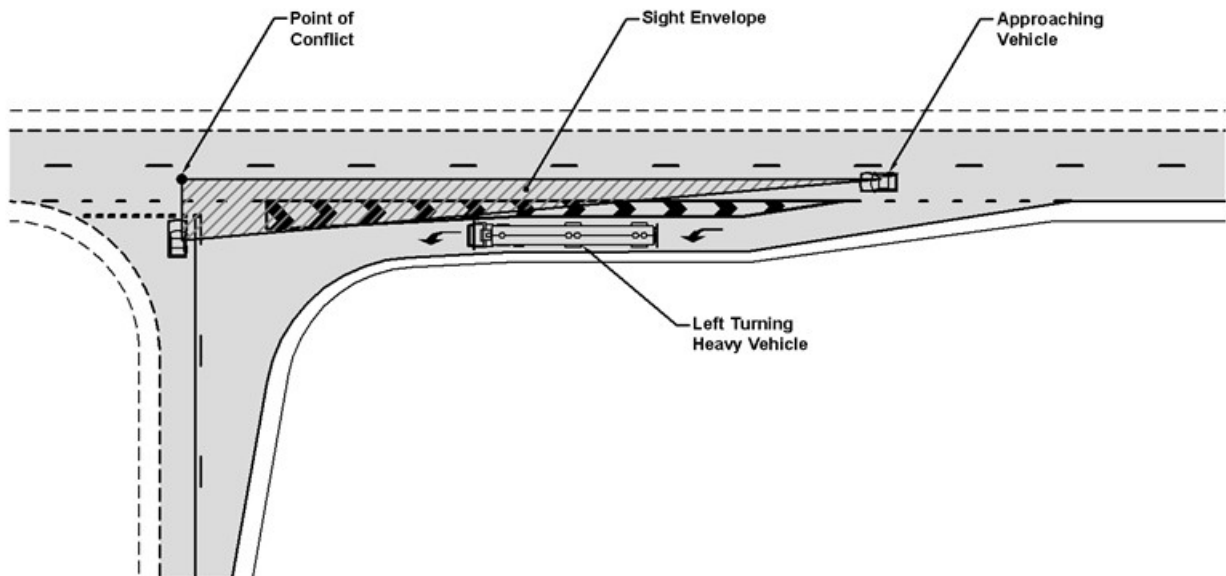
Figure 4A-5 - Offset rural CHL treatment**Notes:**

1. The left-turn channelisation should comply with the layouts for CHL treatments at Section 8.2.4 or *Austroads Guide to Road Design – Part 4 Appendix A Section A 17.1*.
2. The offset from the adjacent through lane is determined based on the provision of MGSD as per Section 3.2.3.
3. Provision of bicycle lanes through the intersection should be as per *Austroads Guide to Road Design – Part 4*. The bicycle lane width can be included within the calculated offset and may negate the need for any further offset.

8.3 Urban left-turn treatments**8.3.1 Urban auxiliary left-turn treatment (AUL) on the major road**Addition

Urban left-turn treatments for motor vehicles involve a conflict with people cycling straight-on. If the left-turn is designed with an auxiliary lane to the left of a bicycle lane, it can result in extended exposure, increased vehicle speed at the conflict point, expanded pavement where conflict can occur and rewarding of poor driving practice. These safety risks can be avoided by implementing physically separated cycle tracks at the intersection. Refer Transport and Main Roads Guideline *Selection and Design of Cycle Tracks*.

8.3.2 Left-turn treatments for large vehiclesAddition

Refer to Transport and Main Roads Guideline *Selection and Design of Cycle Tracks*, for intersection forms which mitigate the risk associated with conflicts for cyclists and pedestrians in these situations.

9 Signalised intersections

Addition

A large amount of design information for signalised intersections has been relocated to Appendix B of *Austroads Guide to Road Design – Part 4*. Austroads will be further reviewing this. The following cross-references are provided to assist designers in the interim.

General

Refer to *Austroads Guide to Road Design – Part 4*, Appendix B, Section B.1.

Design Process

Refer to *Austroads Guide to Road Design – Part 4A*, Section 9.1. Refer also to Section 9.1 below.

Signal Operation Considerations

Refer to *Austroads Guide to Road Design – Part 4*, Appendix B, Section B.2 and the corresponding section in the RPDM, *Supplement to Austroads Guide to Road Design – Part 4*.

Sight Distance

Refer to *Austroads Guide to Road Design – Part 4A*, Section 9.2. Refer also to Section 9.2 below.

Intersection Layouts

Refer to *Austroads Guide to Road Design – Part 4*, Appendix B, Section B.3 and the corresponding section in the RPDM, *Supplement to Austroads Guide to Road Design – Part 4*.

Traffic Lanes

Refer to *Austroads Guide to Road Design – Part 4*, Appendix B, Section B.4

Pedestrian Treatments

Refer to *Austroads Guide to Road Design – Part 4*, Appendix B, Section B.5 and the corresponding section in the RPDM, *Supplement to Austroads Guide to Road Design – Part 4*.

Cyclist Facilities at Signalised Intersections

Refer to *Austroads Guide to Road Design – Part 4*, Appendix B, Section B.6 and the corresponding section in the RPDM, *Supplement to Austroads Guide to Road Design – Part 4*. Refer also to Transport and Main Roads Guideline *Selection and Design of Cycle Tracks*.

9.1 Design process

Addition

At urban signalised intersections, consideration should be given to accommodating cycling movements using protected intersection design - refer Transport and Main Roads Guideline *Selection and Design of Cycle Tracks*.

9.2 Sight distance

Addition

If the road alignment does not provide sufficient sight distance and the existing geometry cannot be adjusted, provision of advance warning signs or advance warning signals (e.g. flashing yellow lights) may be considered as a mitigating device.

References

Transport and Main Roads publication references refer to the latest published document on the departmental website (www.tmr.qld.gov.au).

Addition

Austroads Guide to Road Design Part 3, Geometric Design, Austroads, Sydney, NSW

Austroads Guide to Road Design Part 4, Intersections and Crossings - General, Austroads, Sydney, NSW

Austroads Guide to Road Safety Part 6, Managing Road Safety Audits, Austroads, Sydney, NSW

Austroads Guide to Traffic Management Part 3, Transport Study and Analysis Methods, Austroads, Sydney, NSW

Austroads Guide to Traffic Management Part 6, Intersections, Interchanges and Crossings Management, Austroads, Sydney, NSW

Austroads Cycling Aspects of Austroads Guides, AP-G88-17, Austroads, Sydney, NSW

Austroads Methods for Reducing Speeds on Rural Roads – Compendium of Good Practice, AP-R449-14, Austroads, Sydney, NSW

Standards Australia *AS/NZS 2890.1 Parking Facilities – Part 1: Off-street car parking*

Transport and Main Roads *Cycling Infrastructure Policy*, Brisbane, QLD

Transport and Main Roads *Guideline Bicycle Rider and Pedestrian Underpasses*, Brisbane, QLD

Transport and Main Roads *Guidelines for Cyclists and Pedestrians*

<https://www.tmr.qld.gov.au/business-industry/Technical-standards-publications/Cycling-guidelines>

Transport and Main Roads *Guideline Raised Priority Crossings for Pedestrian and Cycle Paths*, Brisbane, QLD

Transport and Main Roads *Road Planning and Design Manual (RPDM)*, Brisbane, QLD

Transport and Main Roads *Guideline Selection and Design of Cycle Tracks*, Brisbane, QLD

Transport and Main Roads *Manual of Uniform Traffic Control Devices*, Brisbane, QLD

Transport and Main Roads *Traffic Control (TC) Signs*, Brisbane, QLD

Transport and Main Roads *Traffic and Road Use Management Manual (TRUM)*, Brisbane, QLD

Appendix A – Extended Design Domain (EDD) and Design Exception (DE) and potential mitigation strategies for intersections

Addition

The title of Appendix A of *Austroads Guide to Road Design – Part 4A* is changed to reflect that this Appendix deals with both EDD and DE and potential mitigation strategies for intersections.

A.1 General

Addition

This section also provides Design Exception (DE) values and potential mitigation strategies for intersections. These are values outside of the Extended Design Domain (EDD) that have been developed through examining current practice in Queensland, other Australian states and other countries.

A.2 EDD for sight distance at intersections

A.2.2 Base and check cases

Difference

In *Austroads Guide to Road Design – Part 4A*, Table A 1 Case types used for EDD sight distance, the case descriptions for 'Truck-day' and for 'Truck-night' are replaced with the following:

Case type	Case code	Case description
Base case (mandatory application)	Truck-day	Truck driver travelling at the 85th percentile truck speed in daylight hours
Check case (ensure that adequate capability exists under these conditions, as relevant)	Truck-night	Truck driver travelling at the 85th percentile truck speed on an unlit roadway at night

A.2.5 EDD Safe Intersection Sight Distance (SISD)

Difference

Delete the word 'only' in the third dot point of the second sentence, *Longitudinal Deceleration*, to read 'Dry weather stopping is not used under SISD....'

A.5.7 Turning lanes

There is no equivalent Section A.5.7 in *Austroads Guide to Road Design – Part 4A*.

New

Width of turn lanes at intersections is predicated on the turning path of the design vehicle and clearances to adjacent kerbs. It is usual to provide sufficient width to pass a stopped vehicle (combination of lane and shoulder width) and this is addressed in *Austroads Guide to Road Design – Part 4A*. The minimum width is set at 5 m but is not mandatory, the ability to pass a stopped vehicle being allowed to be achieved by using space beyond the kerb line (surface of islands). In such cases, the kerbs must be mountable or semi-mountable and furniture (signals, signs) must be kept clear of the area potentially used by passing vehicles.

The width of a right-turn lane in the median of an intersection is desirably 3.5 m but widths of 3 m have often been used. The minimum width that could be tolerated is 2.5 m which will accommodate a

passenger car. This should only be used if the adjacent lane is 3.5 m wide. This would be a design exception.

Mitigation includes:

- Ensuring the adjacent travel lane is at least 3.5 m.
- Ensuring that the adjacent median can tolerate incursion by the wheels of a vehicle i.e. sufficient clearance to any road furniture and sufficient space for a pedestrian to be shielded. Preferably, the operation of the intersection should be such that pedestrians do not need to be stored on the median during the crossing manoeuvre.

A.5.8 Private accesses

There is no equivalent Section A.5.8 in *Austroads Guide to Road Design – Part 4A*.

New

Private property access on rural roads can become hazardous with reasonably high traffic volumes combined with high speed. Drivers waiting to turn right from the major road are susceptible to rear end collisions. In many cases, it is not feasible to provide separate service roads or to provide a protected right-turn lane for such accesses.

One potential solution is to provide a widened shoulder (3 m with 1 in 25 tapers from the usual shoulder edge) opposite the access to allow the turning vehicle to wait until traffic is clear in both directions and then undertake the right hand turn (sometimes referred to as a 'hook' turn) – Figure 4A-A 1. This solution must be developed in consultation with the property owners. It is important that the size of the widening does not convey a message that it is an overtaking lane.

Left hand turns should be provided with shoulder widening to allow the vehicle turning left to move clear of the through lane edge. 1 in 10 tapers to achieve a 3 m shoulder adjacent to the access is required.

Property accesses should desirably be removed from either side of the crest of sub-standard vertical curves i.e. just over the crest in either direction. In some cases, an access precisely on the crest with equal visibility in both directions will be acceptable; appropriate earthworks to provide suitable visibility of the access will be required. Allowing accesses without at least EDD sight distance is undesirable as there is little in the way of mitigation that can be done. Even if the primary user is familiar with the environment, that user will not be able to detect an oncoming vehicle and to the oncoming vehicle, an entering or exiting vehicle will be a complete surprise with little scope for taking avoiding action. Consultation with the property owner should be undertaken with the objective to relocate the access to a safer location if possible.

Figure 4A-A 1 - Example private entrance widening - Hook right-turns

WIDENING OPPOSITE PRIVATE ENTRANCE

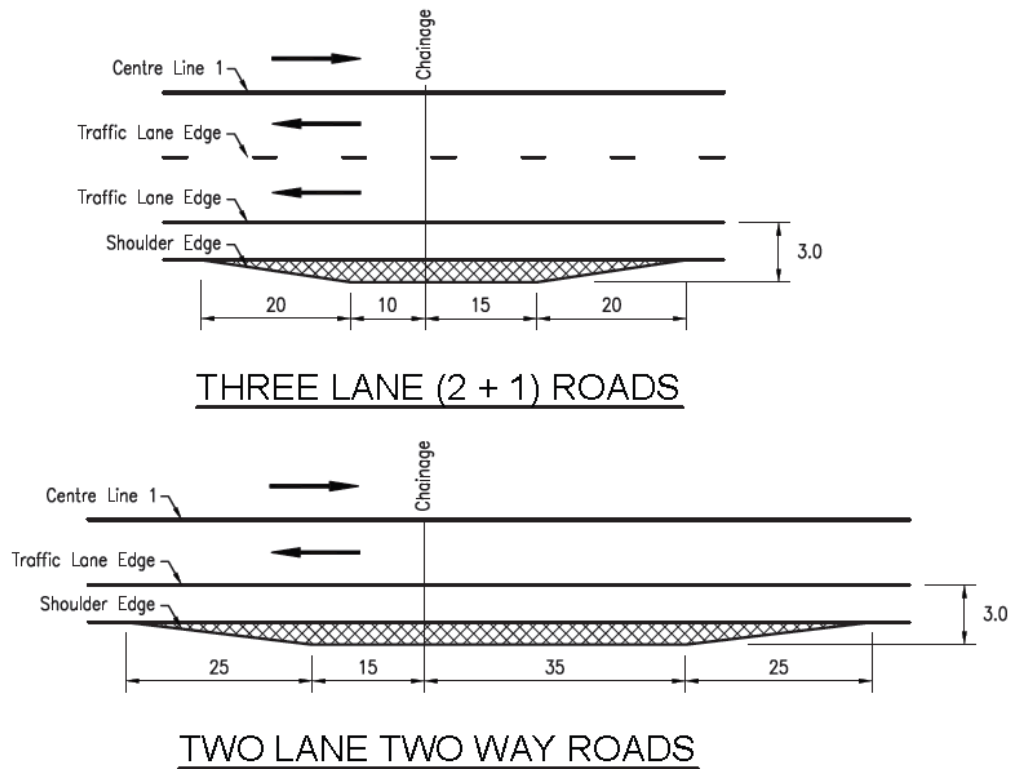

A.6 EDD treatment of a constrained left-turn radius

Addition

The following figures, 4A-A 2 and 4A-A 3 present EDD layouts for BAL turn treatment subject to constraints. These treatments allow for heavy vehicle encroachment onto adjacent lanes when making left-turns into or out of the minor road.

Figure 4A-A 2 - Basic EDD Left-turn Treatment (BAL) on an urban road

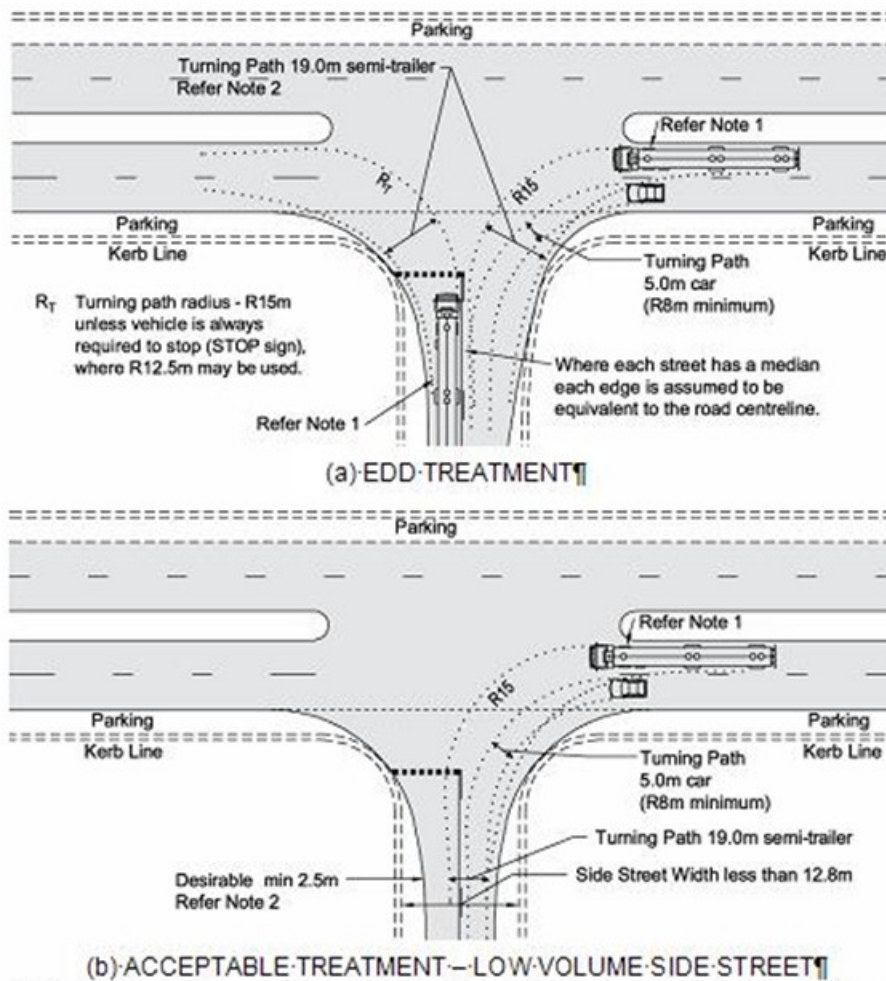

No traffic signals at site or median in side street. Probability of conflict with exiting traffic $\leq 15\%$.

Notes:

1. Where approach is two lanes or more in widths, heavy vehicles (12.5 m long or more) must turn from the kerbside or adjacent lane, unless otherwise controlled by signs and pavement arrows.
2. Where side street approach and/or departure is not used by vehicles over 12.5 m long, a turning path for a bus/truck may be used.
3. This diagram does not show any specific bicycle facilities. Where specific bicycle facilities are required (e.g. exclusive bicycle lanes), refer *Austroads Cycling Aspects of Austroads guides, AP-G88-17*.

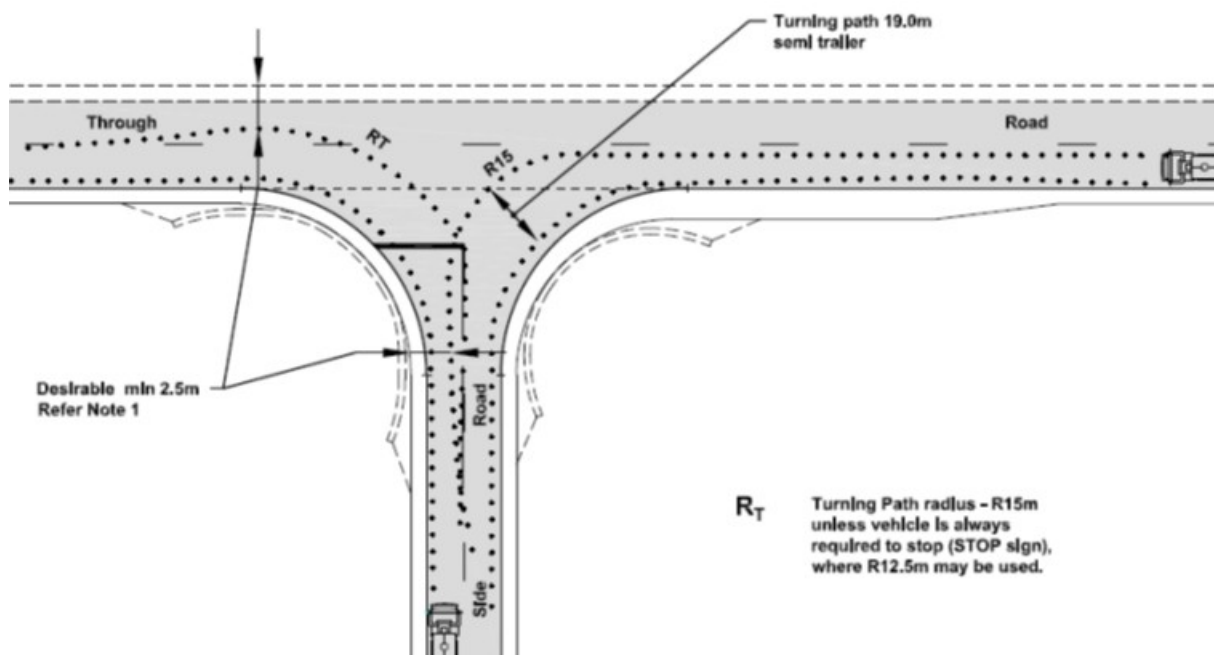
Figure 4A-A 3 - Basic Left-turn Treatment (BAL) on a rural road, side road < 50vpd AADT**Notes:**

1. Minimum distance between outer edge of the swept path and the edge of formation is to be 2.5 m to allow for situations where a vehicle arrives during the large vehicle turning movement and attempts to continue to pass.
2. Layout not to be used when:
 - Annual Average Daily Traffic (AADT) of the side road is more than 50 vehicles/day
 - AADT of the major road is more than 500 vehicles/day
 - there are significant volumes of articulated vehicles (more than about one turning articulated vehicle per day)
 - it is associated with other minimum criteria (e.g. sight distance restricts or tight horizontal curves).
3. This figure shows EDD Swept Paths only. All other dimensions are shown at Figure 8.2 of *Austroads Guide to Road Design – Part 4A*.

A.10 EDD warrants for intersection turn treatments

There is no equivalent Section A.10 in *Austroads Guide to Road Design – Part 4A*.

New

The EDD warrants for determining the preferred intersection turn treatment (refer Figure 4A–A 4) represent alternative design criteria for application at sites subject to site constraints or where the costs of the intersection upgrade are considered impractical. These criteria can therefore be considered for application at brownfields sites where construction costs are higher due to the as-hoc nature of the works and the management of traffic.

These warrants apply to two-lane two-way roads (2L2W) and can be applied for 4L2W and 6L2W roads. MNR intersection types, as discussed in Section 3.2.2 of *Austroads Guide to Traffic Management – Part 6*, may be retained at these intersections subject to a Design Exception evaluation. SR/SL turn treatments are described in Section 4.4 of this supplement.

The EDD Warrants should be applied to NDD turn treatment layouts. Only in extreme constrained situations should the EDD Warrants be combined with the EDD turn treatment layouts. The combination of the two EDD elements should be treated as a design exception.

The warrants in Figure 4A-A 4 are based on achieving a specific level of safety performance. An evaluation of the operational performance of the intersection should also be undertaken. If the operational performance indicates a higher level treatment is needed, then it should be adopted in lieu of the warrants in Figure 4A-A 4.

Further commentary on the methodology behind these warrants is provided at Commentary 6.

Figure 4A-A 4 - Warrants - Major road turn treatments - Extended Design Domain

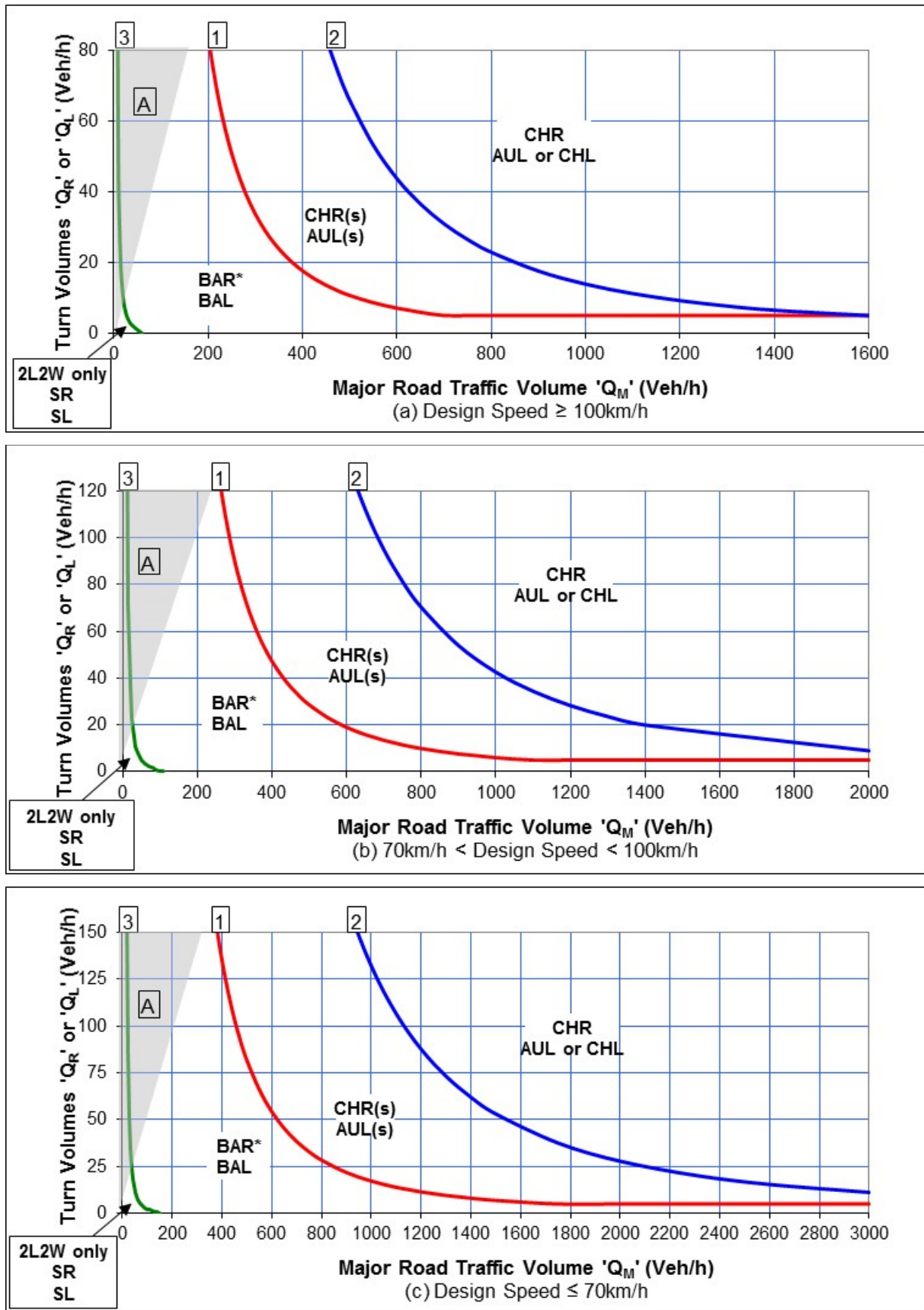

* - the minimum right-turn treatment for multi-lane roads is a CHR(s)

Figures 4A-A 4(d), (e) and (f) respectively expand the view of the bottom left corner of diagrams(a), (b) and (c)

Figure 4A-A 4 (continued)

(expanded view of the bottom left corner of the warrants diagrams at 4A-A 3(a), (b) and (c))

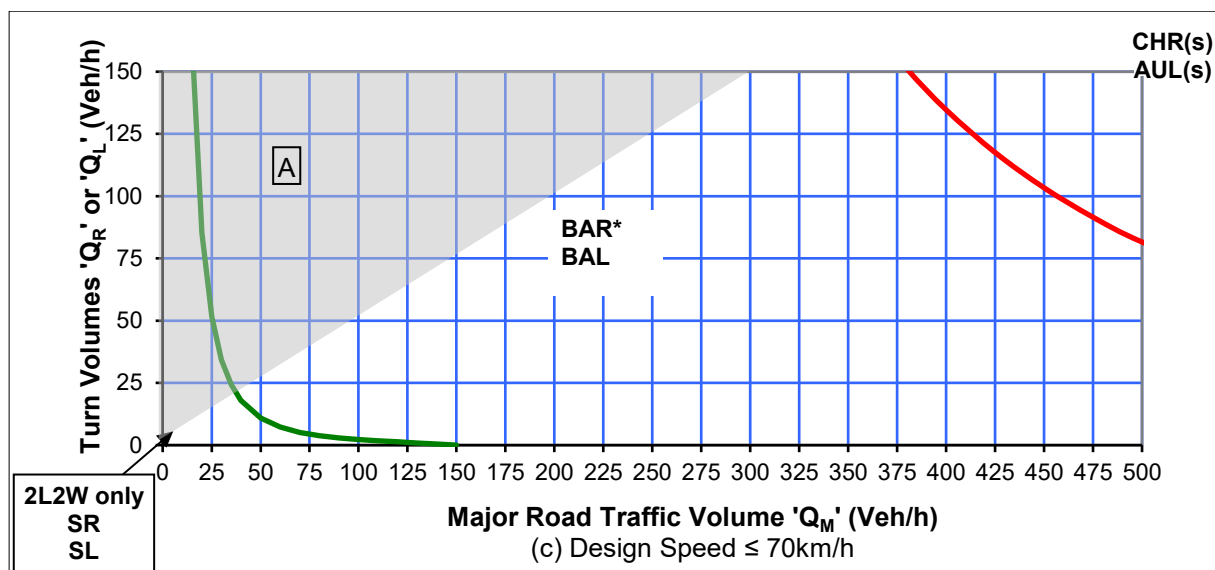
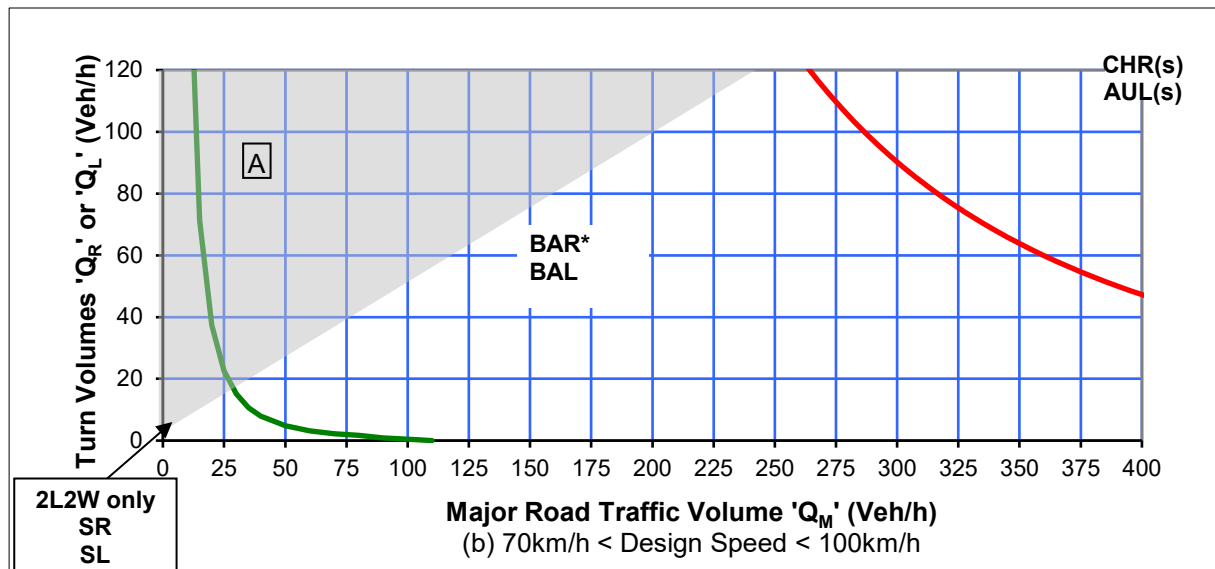
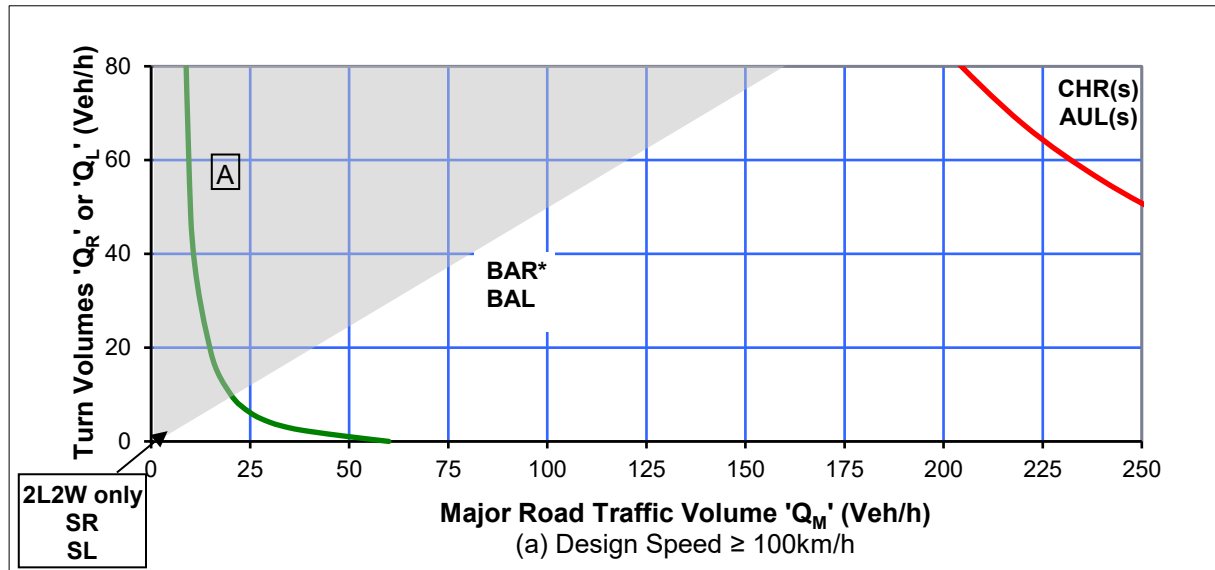

* - the minimum right-turn treatment for multi-lane roads is a CHR(s)

The following notes apply to the warrants in Figure 4A-A 4

1. Curve 1 - For 2L2W roads, curve 1 represents the boundary between a BAR and a CHR(S) turn treatment and between a BAL and an AUL(S) turn treatment. For 4/6L2W roads, curve 1 represents the boundary between a BAL and an AUL(S) turn treatment only. The minimum right-turn treatment is a CHR(s) on 4/6L2W roads.
2. Curve 2 represents the boundary between a CHR(S) and a CHR turn treatment and between an AUL(S) and an AUL/CHL turn treatment. The choice of CHL over an AUL will depend on factors such as the need to change the give way rule in favour of other manoeuvres at the intersection and the need to define more appropriately the driving path by reducing the area of bitumen surfacing.
3. Curve 3 represents the boundary between a Simple Intersection Treatment and a BAR/BAL turn treatment for 2L2W roads only.
4. The warrants apply to turning movements from the major road only (the road with priority). For turns from the minor road, turn treatments are determined through an operational performance evaluation applying gap acceptance analysis and an evaluation of acceptable delays and queues.
5. Q_M
 - a) For 2L2W roads, Figure 4A-A 5 is to be used to calculate the value of the major road traffic volume parameter (Q_M) and is the total through traffic flow in both directions ($Q_{T1} + Q_{T2}$).
 - b) For 4/6L2W roads, the major road traffic volume parameter (Q_M) for right-turns uses the full opposing flow Q_{T2} and only the traffic flow in the nearest lane of the following flow Q_{T1} as per Figure 4A-A 5. For left-turns the major road traffic volume parameter (Q_M) uses only the traffic flow in the leftmost through lane of the following flow Q_{T2} .

Figure 4A-A 5 - Calculation of the major road traffic volume parameter ' Q_M '

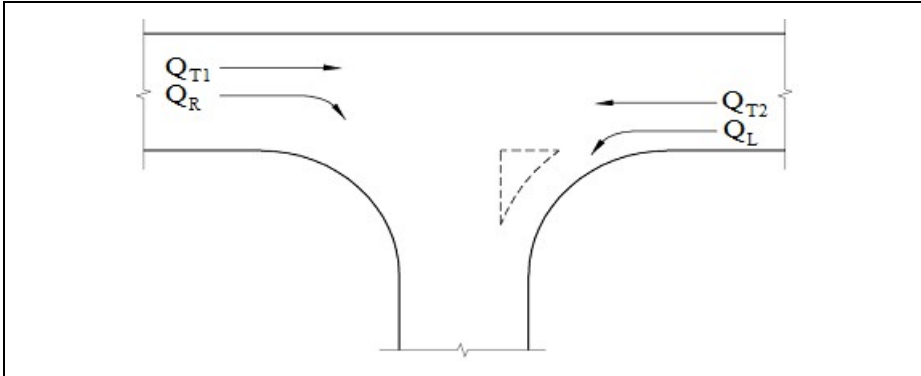

Road Type	Turn Type	Splitter Island	Q_M (veh/h)
2 Lane 2 Way	Right	No	$= Q_{T1} + Q_{T2} + Q_L$
		Yes	$= Q_{T1} + Q_{T2}$
	Left	Yes/No	$= Q_{T2}$
4 Lane 2 Way	Right	No	$= 50\% \times Q_{T1} + Q_{T2} + Q_L$
		Yes	$= 50\% \times Q_{T1} + Q_{T2}$
	Left	Yes/No	$= 50\% \times Q_{T2}$
6 Lane 2 Way	Right	No	$= 33\% \times Q_{T1} + Q_{T2} + Q_L$
		Yes	$= 33\% \times Q_{T1} + Q_{T2}$
	Left	Yes/No	$= 33\% \times Q_{T2}$

6. Traffic flows applicable to the warrants are peak hour flows, with each vehicle counted as one unit (i.e. do not use equivalent passenger car units [pcus]). Where peak hour volumes or peak hour percentages are not available, assume that the design peak hour volume equals 15% of the AADT for 500 hours each year, use 5% of the AADT for the rest of the year

7. If more than 50% of the traffic approaching on a major road leg turns left or right, consideration needs to be given to possible realignment of the intersection to suit the major traffic movement. The shaded area (A) denotes the traffic flow combinations where this occurs. However, route continuity issues must also be considered (for example, realigning a highway to suit the major traffic movement into and out of a side road would be unlikely to meet driver expectation).
8. If a turn is associated with other geometric minima, consideration should be given to the adoption of a turn treatment of a higher order than that indicated by the warrants.
9. At higher traffic volumes, consideration should also be given to the operational performance of the intersection which may require a higher level turn treatment, or alternative intersection control, than required by these warrants based on crash analysis.

A.11 Island size

There is no equivalent Section A.11 in *Austroads Guide to Road Design – Part 4A*.

New

Austroads Guide to Road Design – Part 4A, Section 6.1.2 provides guidance on the minimum island sizes that should be adopted. If a smaller island than that shown in *Austroads Guide to Road Design – Part 4A*, Table 6.1 and 6.2 is to be installed, it is a design exception and the following issues must be considered in justifying its acceptance.

Considerations for design exceptions

In assessing the size of a raised island at an intersection, the fundamental consideration is that of the function of the particular island and how it satisfies that requirement. The usual functions include:

- separation of traffic streams (same or opposite direction)
- prevention of use of certain areas by traffic
- space for the erection of signs, traffic signals and lighting poles, and
- space for pedestrian refuge which considers demand and caters for disability access (mobility devices).

An island may fulfil any combination of these functions but will almost always need to cover the first two dot points above. Signs, signals and poles may or may not be required (lighting poles should be avoided as there will usually be an alternative location that can provide a suitable solution).

Pedestrians are not always present and sometimes only in small numbers.

If the space available for the island is too small, it will become more of a hazard in itself and a painted island will suffice.

Where signs are required in the island, there must be sufficient space to accommodate the full width of the sign plus clearance to the edges of the sign as defined in the MUTCD. In rural areas, the minimum clearance to the edge of the sign is 600 mm from the road edge. In urban areas, the minimum is 300 mm from the face of the kerb but 500 mm from the face of a mountable or semi-mountable kerb. Hence the width of the island required will be the width of the sign plus the required clearance on both sides.

The length of the island may need to be shorter than the dimensions provided in *Austroads Guide to Road Design – Part 4A*, Table 6.1. A sensible minimum, given severe site constraints could be taken as 2 x the width determined from the functional requirements with a minimum of 3 m. Such an island would be very small in area and would need significant treatment to ensure sufficient conspicuity.

A.11.1 Mitigation

There is no equivalent Section A.11.1 in *Austroads Guide to Road Design – Part 4A*.

New

The major issue with a small island will be its conspicuity. Additional measures to make the island conspicuous will be required. This could include:

- painting the island and kerbs in chevron style with high reflectivity paint
- using wider lead-in lane lines and raised pavement markers, and
- lighting will be essential.

Appendix B – Truck stability at intersections

B.2 Lateral friction force on vehicles

Difference

Figure B 1 of the *Austroads Guide to Road Design – Part 4A* is accepted for use up and including speeds of 50 km/h. Transport and Main Roads is aware of additional research work which suggests alternative Lateral Friction Factors for trucks at speeds above 50 km/h. In this guide, speeds above 50 km/h are not considered generally appropriate for the truck design speed for turning movements. Where designs are based on truck turning speeds greater than 50 km/h, specialist input should be sought and reference should be made to Volume 3, Part 3 of the RPDM.

Appendix D – Basic Left-Turn (BAL) layouts at rural intersections

There is no equivalent Appendix D in *Austroads Guide to Road Design – Part 4A*.

New

This appendix provides set-out details to cater for various design vehicles at rural BAL turn treatments.

Figure 4A-D 1 - Details of type 'BAL' layout for rural sites to suit B-double operation

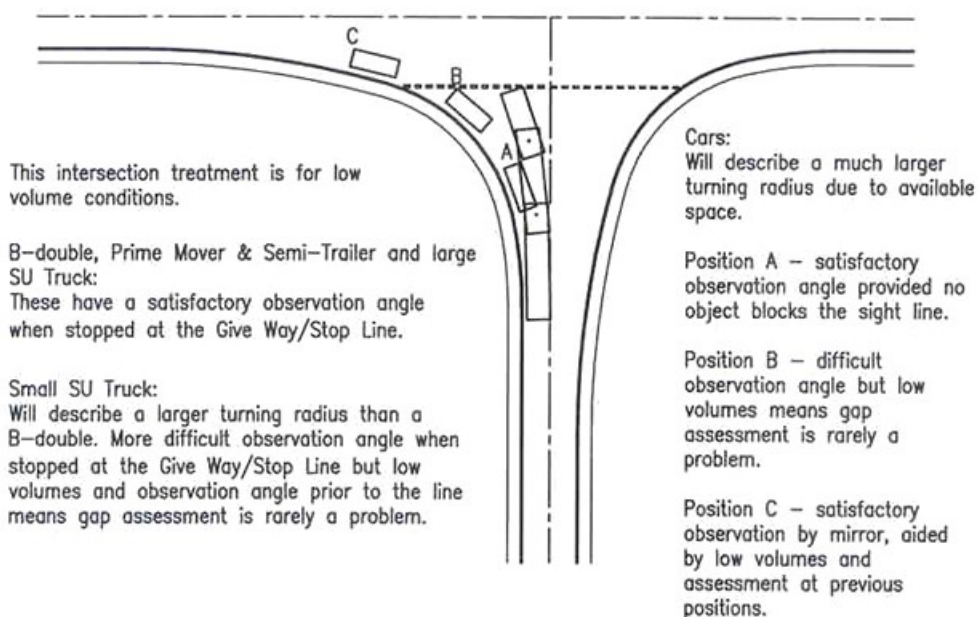
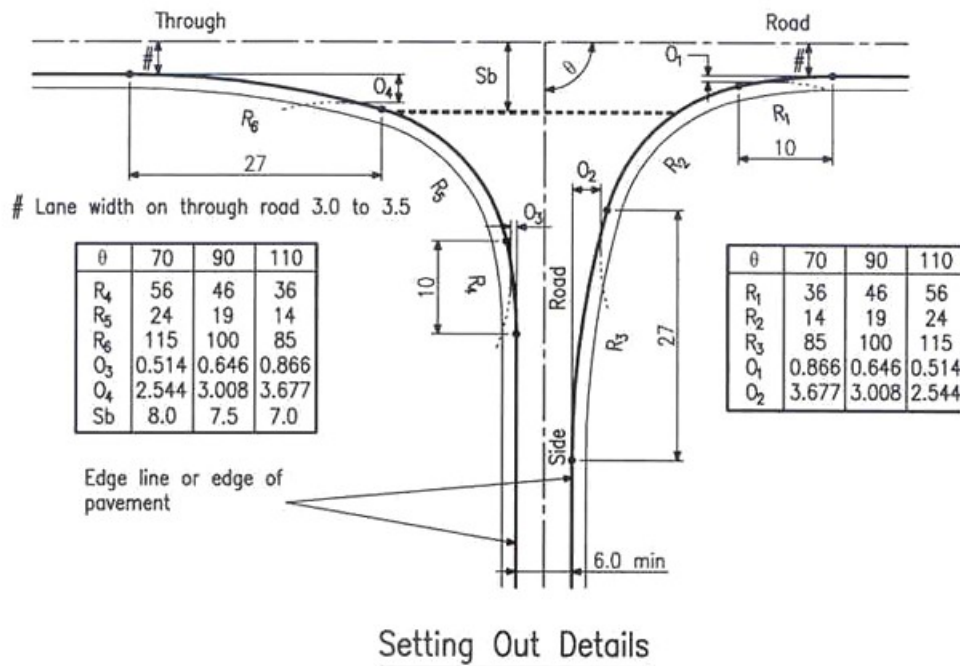
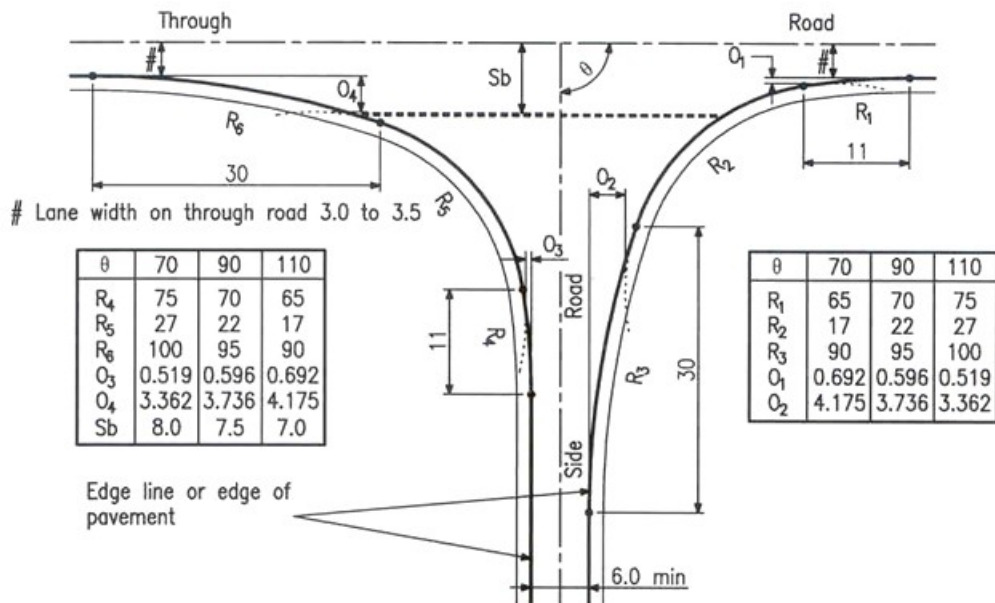
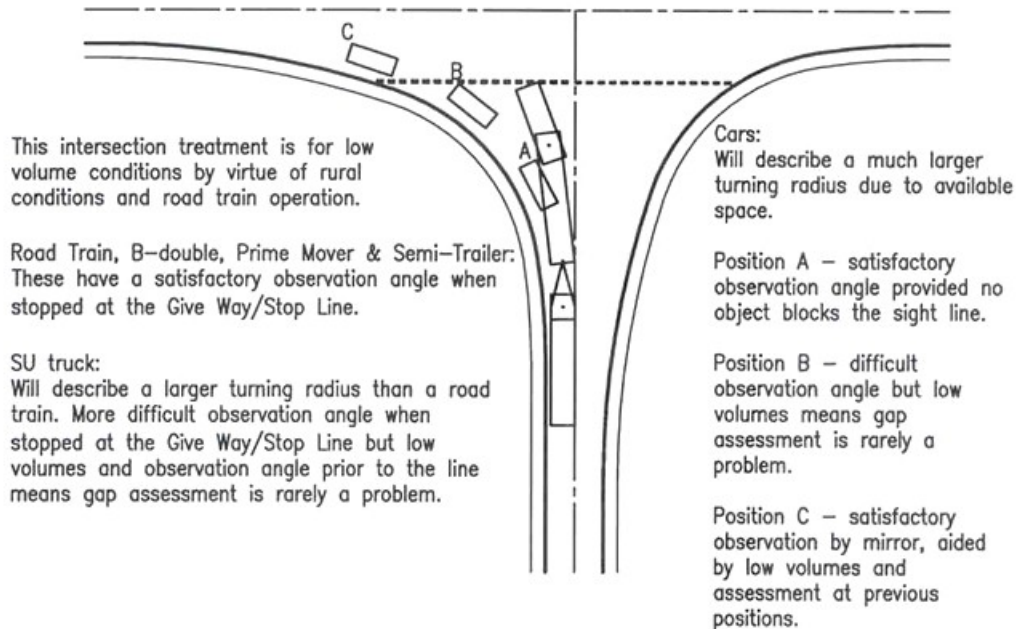

Figure 4A-D 2 - Details of type 'BAL' layout for rural sites to suit type 1 (double) road train operation



Setting Out Details



Observation Angle Assumptions

Figure 4A-D 3 - Details of type 'BAL' layout for rural sites to suit type 2 (triple) road train operation

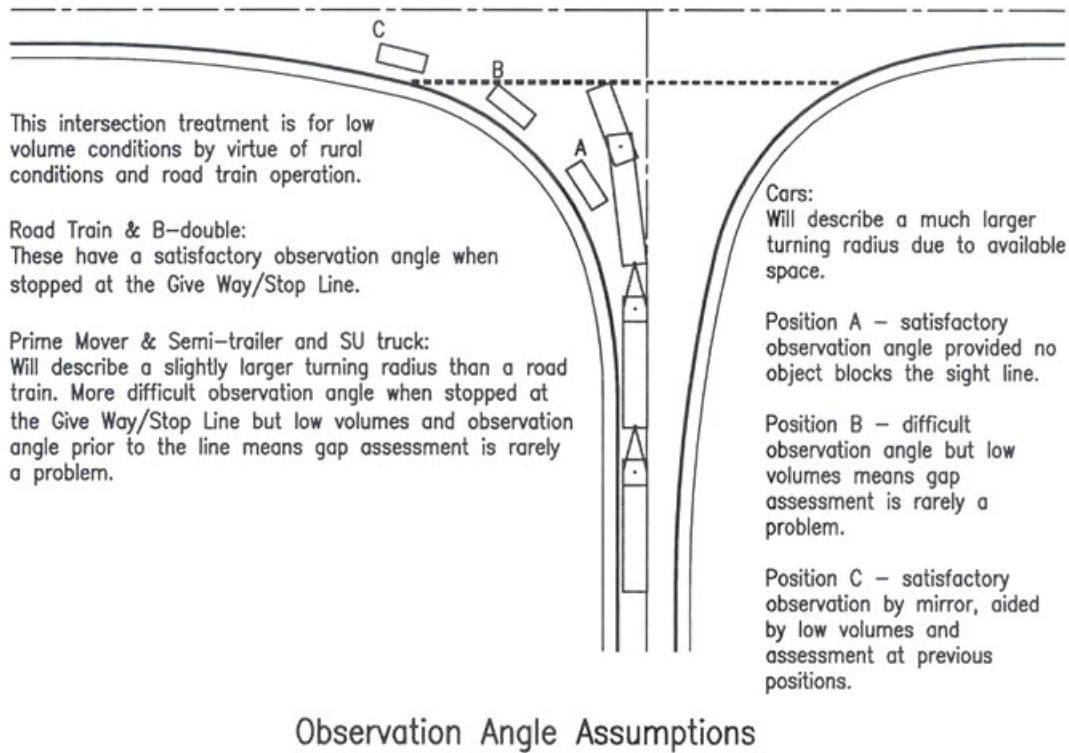
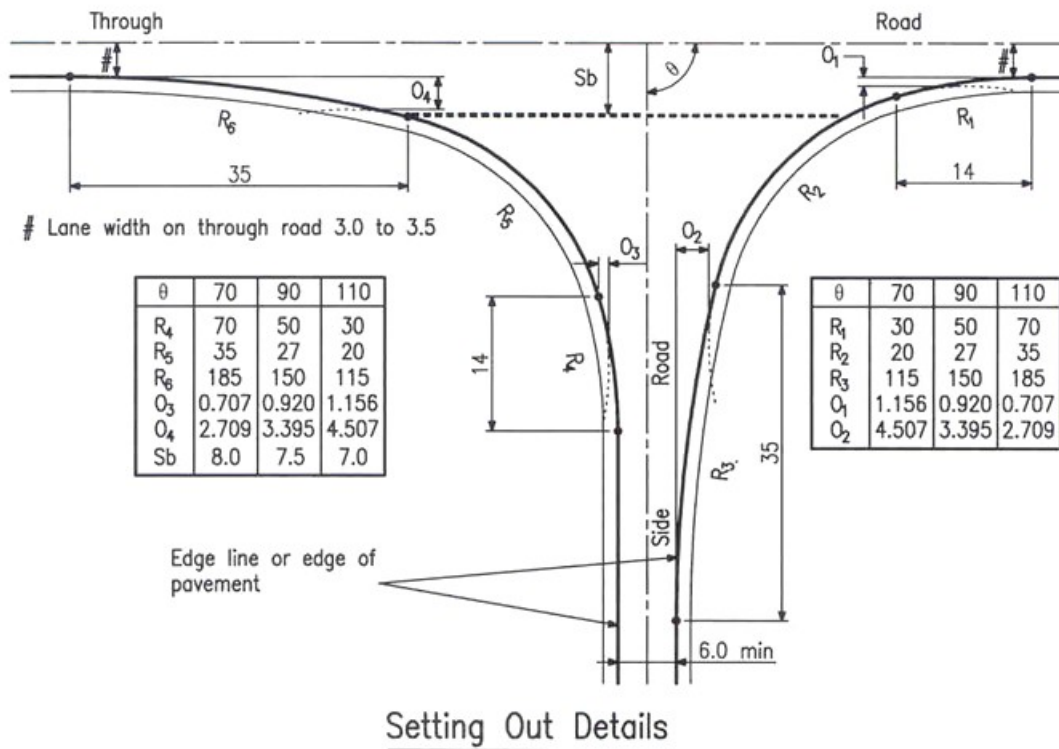

Commentary 6

There is no equivalent Commentary 6 in *Austroads Guide to Road Design – Part 4A*.

New

Austroads Guide to Traffic Management – Part 6 details NDD warrants for selection of intersection turn treatments at unsignalised intersections. Appendix A.10 provides details the respective EDD warrants. Both of these sets of warrants are based on the mathematical relationships described in this Commentary.

In highly constrained circumstances, the mathematical approach in this section may be used to undertake a more detailed calculation based on site specific factors including the site-specific construction cost estimate for each level of turn treatment and the historical crash rate. This resultant BCR assessment can then be used to evaluate the possible design exception.

The safety benefits, determined from the reduction in estimated accident costs, are estimated for using a higher order left or right-turn treatment as calculated in Equation 4A–6.1.

$$C_{RM} = 2.75 \times 10^{-12} \times C_A \times T_{DL} \times Q_i^{0.406} \times Q_M^{0.912} \times S_{MT}^{2.94} \times (e^{TT_M} - e^{TT_A})$$

(Equation 4A–6.1)

Where:

C_{RM}	=	safety benefit of using the higher order turn treatment (\$)
C_A	=	average cost of a Rear-End-Major vehicle accident = \$38,974 from Arndt (2004)
T_{DL}	=	design life (years)
Q_i	=	turning traffic flow from the major leg (veh/h) (Q_R or Q_L as per Figure 4A-A 4)
Q_M	=	traffic flow (veh/h) on the major legs according to Figure 4A-A 4
S_{MT}	=	85th percentile through major road speed (km/h)
TT_M	=	type of lower-order turn treatment (values given below)
TT_A	=	type of higher-order turn treatment (values given below)
		MNR = 4.59, BAR=3.83, CHR(S) & CHR=0.00, BAL=0.666, AUL(S) & AUL=0.0493

Example Calculation

The safety benefit of providing a CHR turn treatment in lieu of an existing BAR turn treatment for the following conditions:

Design life	' T_{DL} '	= 10 years
Design right-turn traffic flow	' Q_R '	= 60 veh/h
No splitter island opposite the right-turn		
Design approaching through traffic flow	' Q_{T1} '	= 190 veh/h
Design opposing through traffic flow	' Q_{T2} '	= 200 veh/h
Design opposing left-turn traffic flow	' Q_L '	= 50 veh/h
85th percentile through speed	' S_{MT} '	= 70 km/h

Answer

$Q_M = Q_{T1} + Q_{T2} + Q_L = 190 + 200 + 50 = 440$ veh/h from Figure 4A-A 4 (for no splitter island).

Lower-order turn treatment ' TT_M ' = 3.83 for a BAR

Higher-order turn treatment ' TT_A ' = 0 for a CHR

Using Equation 4.8.1:

$$C_{RM} = 2.75 \times 10^{-12} \times 38974 \times 10 \times 60^{0.406} \times 440^{0.912} \times 70^{2.94} \times (e^{3.83} - e^0)$$

$$= \$17,429$$

